

OPERATOR'S MANUAL

OPM04

OPERATOR'S

MANUAL

LOGOMAT s.r.l.

Via V. Nazionale n°79

40065 Pianoro - Bologna (Italia)

Tel. (+39) 051 6260070

Fax (+39) 051 6260111

E-mail: support.opm@logomat.it

www.logomat.it

Contents

| | |
|---|----|
| 1. Introduction..... | 4 |
| 1.1. Preliminary information | 4 |
| 1.2. Outside interface | 4 |
| 1.3. Menu | 4 |
| 2. Machine status display | 5 |
| 2.1. Display..... | 5 |
| 3. Menu..... | 6 |
| 3.1. Main menu..... | 6 |
| 3.2. Size..... | 6 |
| 3.2.1 Set size | 7 |
| 3.2.2 Load size | 7 |
| 3.3. Selectors-timers | 7 |
| 3.4. Counters..... | 7 |
| 3.5. Counters reset | 8 |
| 3.6. Language selection..... | 8 |
| 3.7. Information | 8 |
| 3.8. Data Transfer..... | 8 |
| 3.8.1 Backup and data update..... | 9 |
| 3.9. End..... | 9 |
| 4. Hardware description..... | 10 |
| 4.1. Face..... | 10 |
| 4.1.1 Front face..... | 10 |
| 4.1.2 Back face | 11 |
| 4.1.3 I/O display card (optional) | 12 |
| 4.2. Memories | 13 |
| 4.3. Dimensions | 13 |
| 4.4. Power supply | 14 |
| 4.5. Interface ports..... | 14 |
| 4.6. Serial connection cable | 16 |
| 4.7. Program updating..... | 16 |
| 4.8. Failures | 16 |

1. Introduction

This chapter provides preliminary information concerning the OPM04 operator's panel and an overview of the applications it contains.

1.1. Preliminary information

The OPM04 is an operator's panel designed by Logomat over time with the specific aim of creating a valid connection between the automatic machine and the operator controlling it. The OPM04 combines all the components pertaining to machine warnings and controls.

The operator's panel is able to:

- Display the machine status.
- Manage the Menus.
- Manage the machine.

1.2. Outside interface

The machine status is displayed on a 4-line LCD (twenty characters per line) 9mm high.

The messages are written with a specific software (see *Editor OPM04 software manual*).

The management program of the machine is realized and downloaded by means of a specific software named *Editor PLC*.

1.3. Menu

The OPM04 is capable of managing menus that include a series of utilities (counter manager, selector manager, timers manager, etc.).

2. Machine status display

This chapter describes the procedures to see the display messages.

2.1. Display

Upon switching on, the display carries out a series of internal tests. If they are successful, the display passes to the machine status display function. The message on the display depends on the bit coding 3.0÷3.6 (input port 3) or on the PLC program installed.

A message can be displayed either fixed or flashing.

The message can also display some counters.

Press the  key to display an additional help message.

3. Menu

This chapter describes how to access the different menus and functions.

The available basic menus are:

- Main menu.
- Size.
- Selectors-Timers.
- Counters.
- Counters reset.
- Language selection.
- Information.
- Input/output transfer.
- End.

3.1. Main menu

Press the  key to access the "Main menu". From here it's possible to access a series of submenus or exit this mode by pressing "End".

Use the   keys to scroll the menu. When the  arrows points to the desired function/submenu, press .

 If the  symbol precedes the key, activate the hardware key before pressing .

3.2. Size

Select "Size" on the main menu to access a menu containing two items:

- SET SIZE
- LOAD SIZE

3.2.1 Set size

Set size contains the list of the size names. By selecting the desired size  with , the positions of the selector/timers concerning that particular size will be memorized.

To scroll the list use   the keys.

Press  on "end" to return to the Main menu.

3.2.2 Load size





Load size contains the list of the size names. By selecting the desired size  with , different selectors will be set as they were memorized.

To scroll the list use the   keys.

Press  on "end" to return to the Main menu.

3.3. Selectors-timers

The selector/push button/timer list enables to change their status. To modify the status of a selector/push button, select it and press .

In the case of a push button the corresponding output will remain 1 as long as the  key is hold pressed. Whereas for a selector/timer, its status will change every time the  key is pressed. To change the selector/timer status, the   keys can be used.

To scroll the list use   the keys.

Press  on "end" to return to the Main menu.

3.4. Counters

The counter list enables to see the value of all the counters set, except the counter concerning the machine speed.

To scroll the list use   the keys.

Press  on "end" to return to the Main menu.

3.5. Counters reset

This list contains all the counters that can be reset by the user.

To scroll the list use   the keys. To reset press  when the arrow → points to the counter to reset.

Press  on "end" to return to the Main menu.

3.6. Language selection

This list contains all the languages available for the customer.

To scroll the list use   the keys.

Press  on "end" to return to the Main menu.



If a wrong language is selected, press  on the message preceded by * to return to language selection.

3.7. Information



This menu item contains the firmware version and the checksum of the display management program as well as the management software. This information will be displayed for some seconds, then the input/output status of the first board O 010 - I 020 - I 030 will be displayed. By means of  the key, it is possible to display the input/output status of the second board O 040 - I 050 - I 060.

Press  or  to return to the Main menu.

3.8. Data Transfer

This function enables the serial port to establish a PC connection. Press  to disable the function and return to the Main menu.



To activate the function for "On-line display" of the variables, position the  arrow to the item "Data transfer" on the Main menu, hold  pressed and press . 3 beeps will sound to confirm the activation of the function. This function can only be used if you have the Editor PLC program. During its use, it could slow down some display functions and result in some failures when scrolling the menu, in the counters display as well as slow down the execution of the PLC program.

3.8.1 Backup and data update.

From page "Data Trasfer", using the button , it is possible to access the backup function and the update of the program OPM04 (messages and management program of the machine).

It is necessary to have a USB drive to insert in the CNxx connector.

The available functions are:

- **RESTORE:** It allows you to copy messages and machine management program from the USB drive to the OPM.
- **BACKUP:** It allows you to copy messages and machine management program from the OPM to the USB stick. (Contact LOGOMAT srl company to get the password needed to perform the operation.)
- **COMPARE:** It allows you to compare the contents of the USB stick with the messages and the machine management program currently in OPM.
- **RETURN:** to return to the main Menu.

To scroll the list use   the keys.

Pressing  the command selected is executed.

3.9. End

Select "End" to return to the machine status display function.

4. Hardware description

This chapter describes the display technical features.

4.1. Face

The OPM04 operator's panel has two faces:

1. Front
2. Back

4.1.1 Front face

The front face is the panel side visible to the operator that contains the display and the function keys.

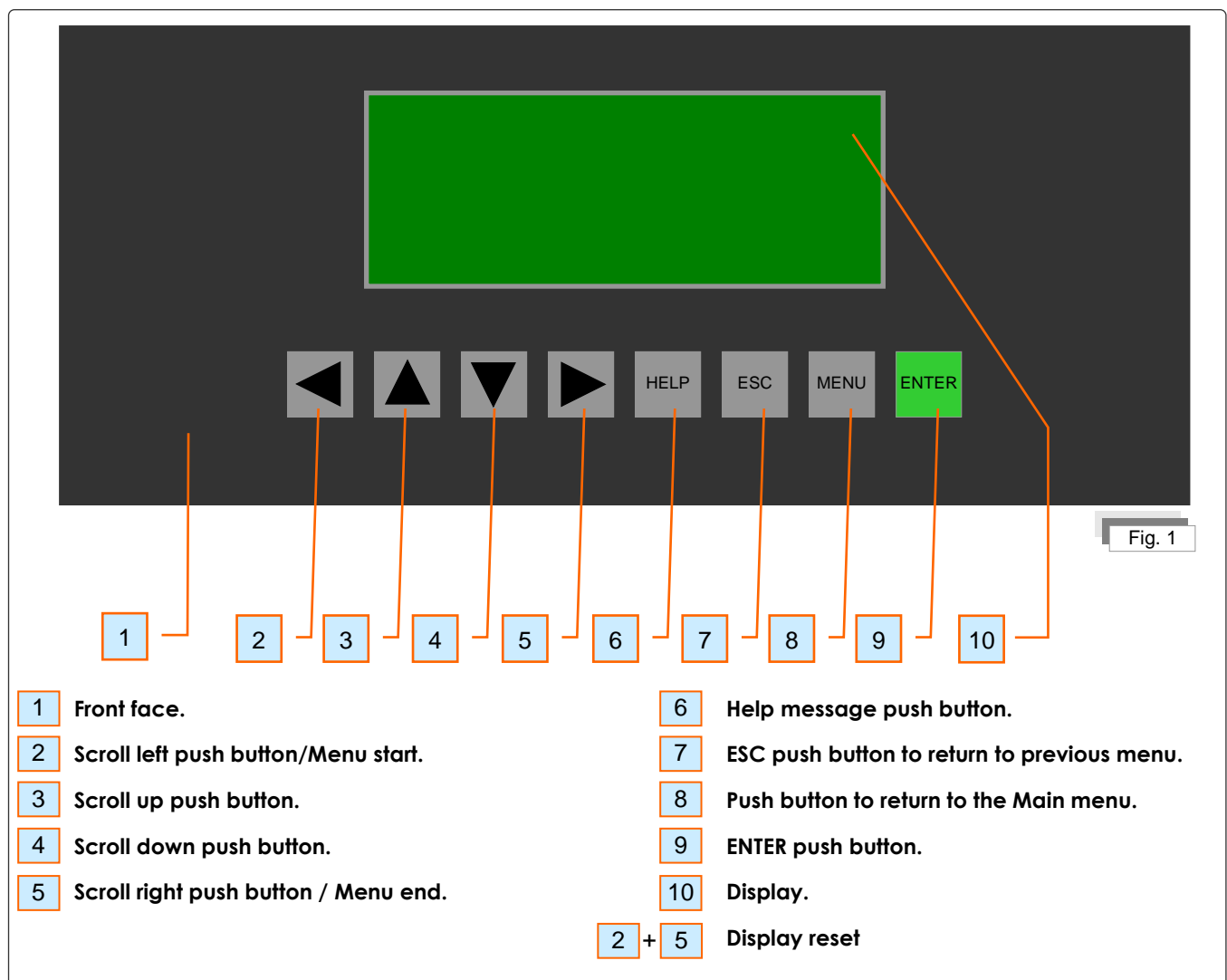

4.1.2 Back face

The back face (Fig. 2) has 4 well-defined areas:

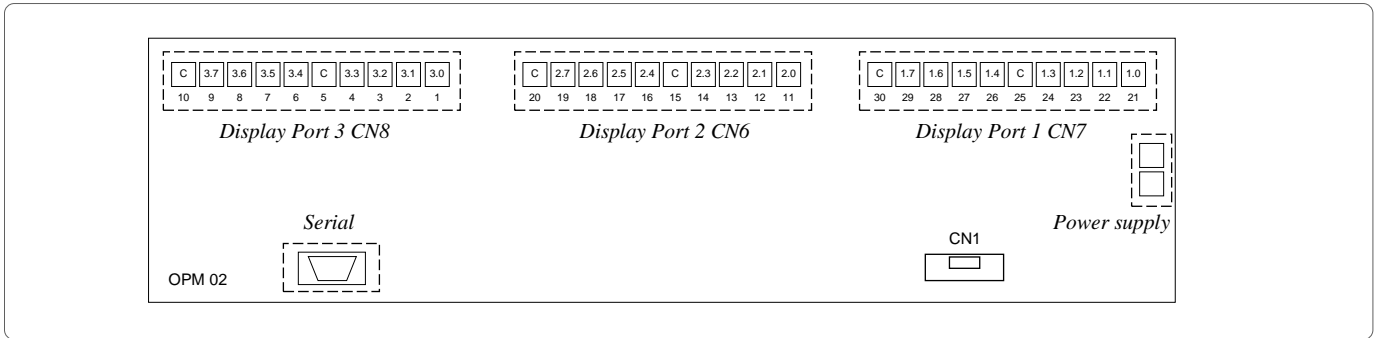

Fig. 2

- **Port 1.** It comprises 10 terminals for coded output signals. The port coding corresponds to the value "1.X" ("4.X" for the expansion board) where 1 indicates the port and X identifies one of the connectors whose value range is between 0 and 7. The two connectors marked with "C" must be connected to the common.

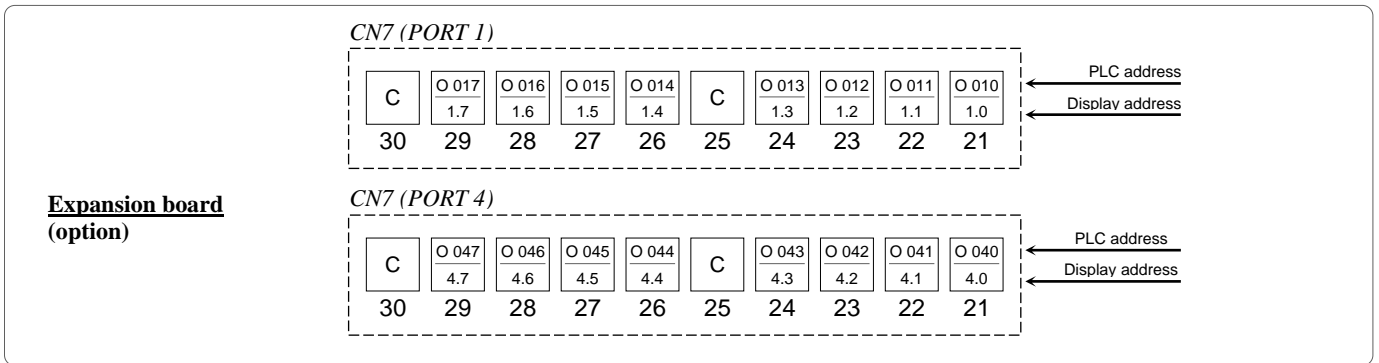

Fig. 3

- **Port 2.** It comprises 10 terminals for coded input signals. The port coding corresponds to the value "2.X" ("5.X" for the expansion board) where 2 indicates the port and X identifies one of the connectors whose value range is between 0 and 7. The two connectors marked with "C" must be connected to the common.

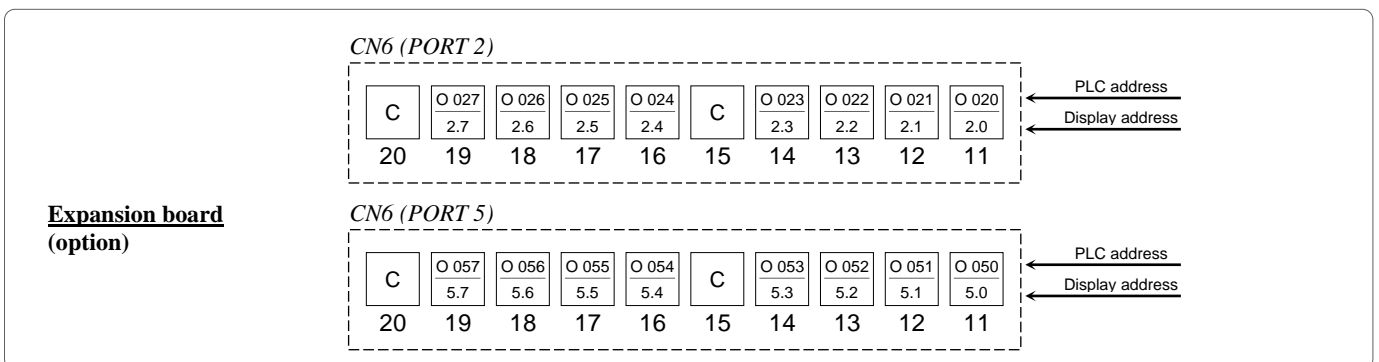

Fig. 4

- **Port 3.** It comprises 10 terminals for the display message loading input. The port coding corresponds to the value "3.X" ("6.X" for the expansion board) where 2 indicates the port and X identifies one of the connectors whose value range is between 0 and 7. The two connectors marked with "C" must be connected to the common.

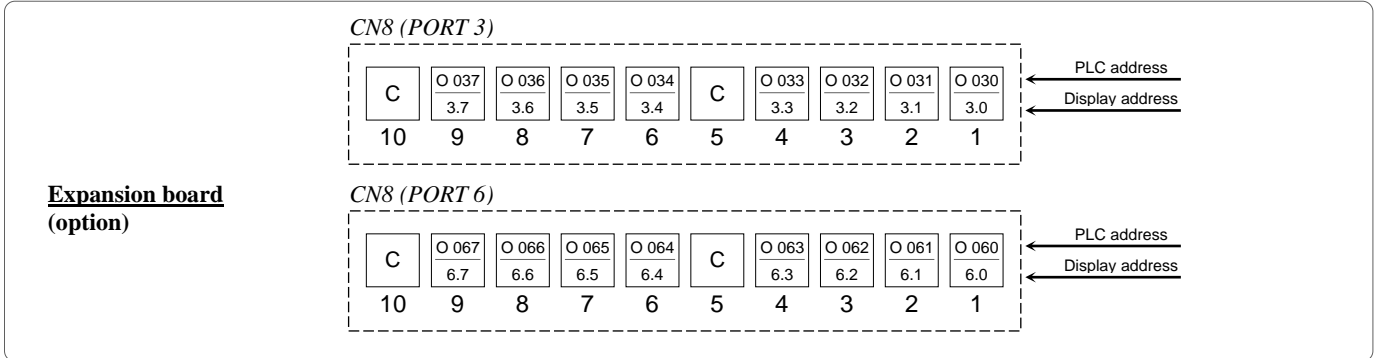

Fig. 5

- **Serial port.** The serial port connection is not standard. Therefore use an adequate adapter for the OPM04 and the PC. The communication takes place by means of a RS232 port.

4.1.3 I/O display card (optional)

The I/O display card named CN1 comprises three groups of LEDs. Each group is associated with an input/output port. The LEDs turn on every time there is a signal on the input/output linked to it.

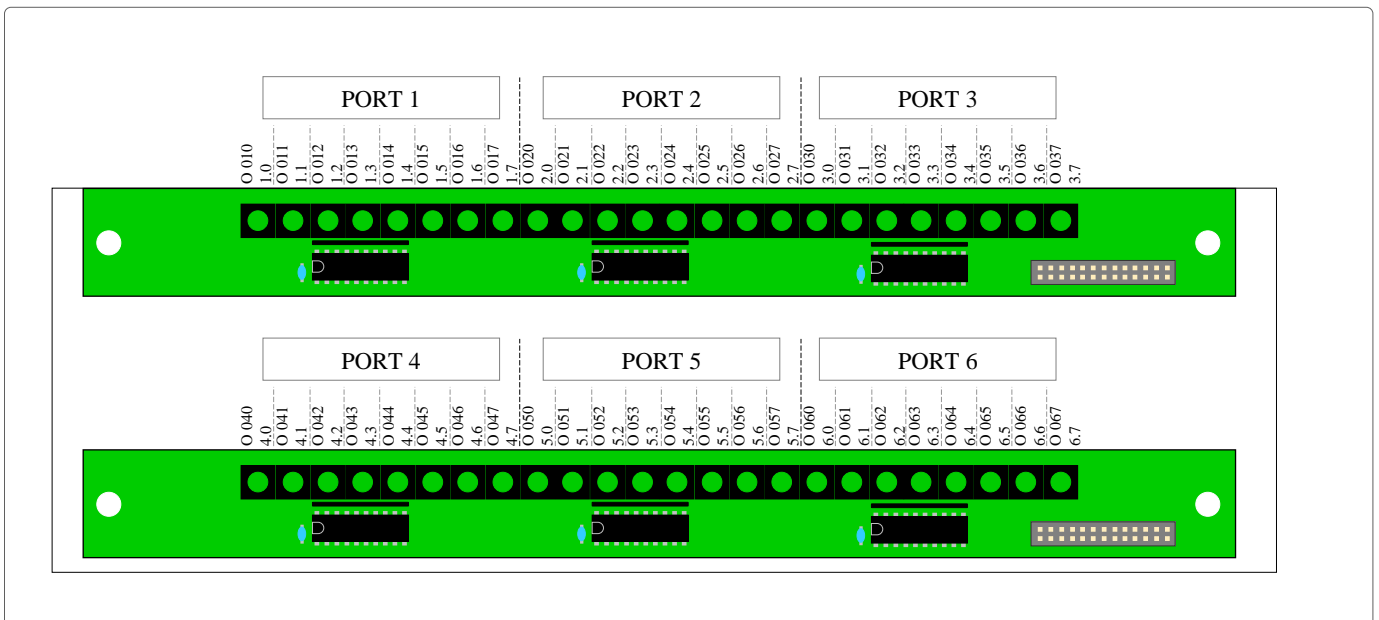

Fig. 6

4.2. Memories

The OPM04 has three different internal memories:

- 1 32-KBYTE FLASHEPROM
- 1 256-KBYTE FLASHEPROM
- 1 8-KBYTE BUFFER RAM

4.3. Dimensions

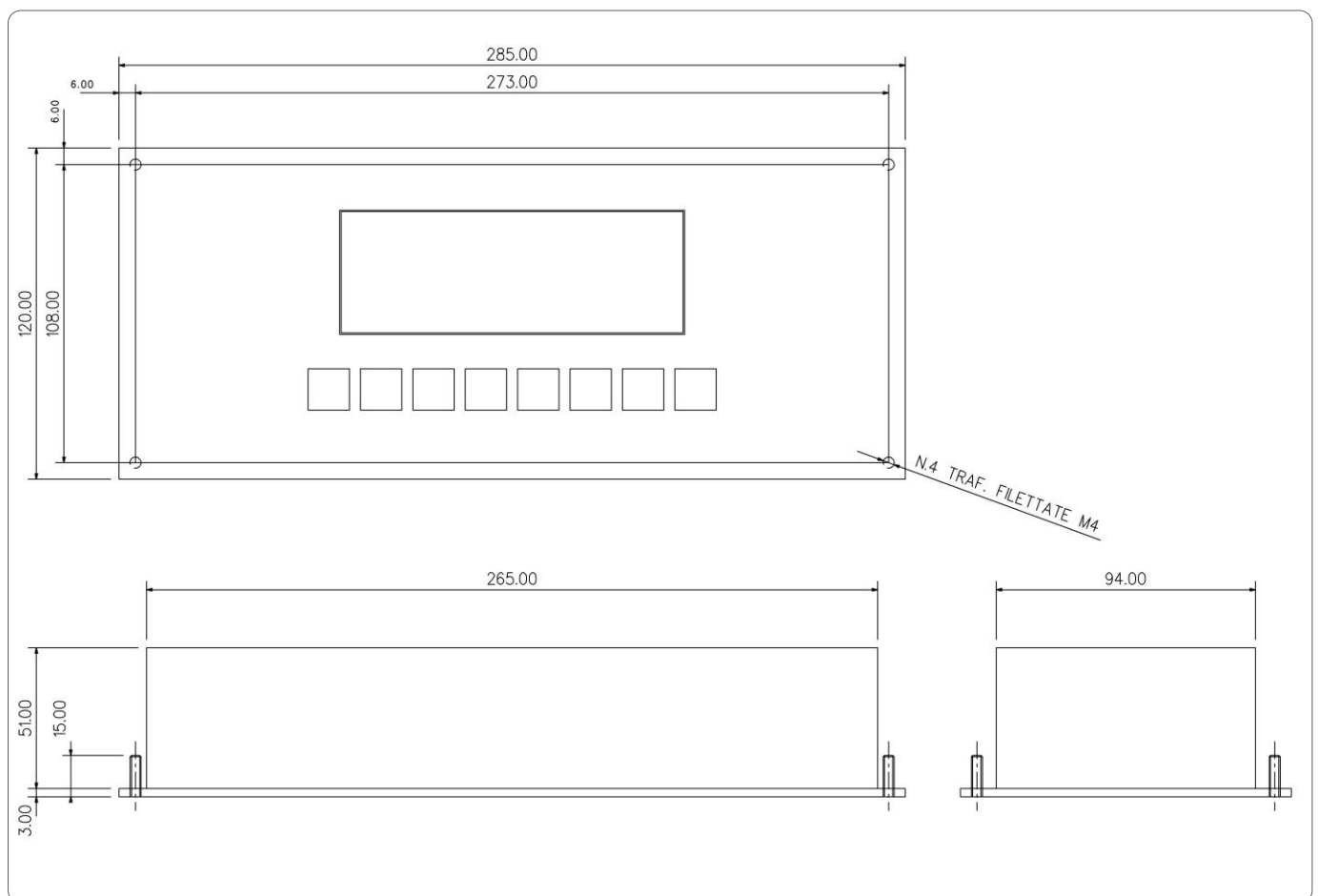



Fig. 7

4.4. Power supply

| 2-pole power connector | | | |
|---|---|--------------------------|---|
|  | L | 12-24Vac/Vdc power input | (the poles are interchangeable also in dc current powering) |
| | N | 12-24Vac/Vdc power input | |

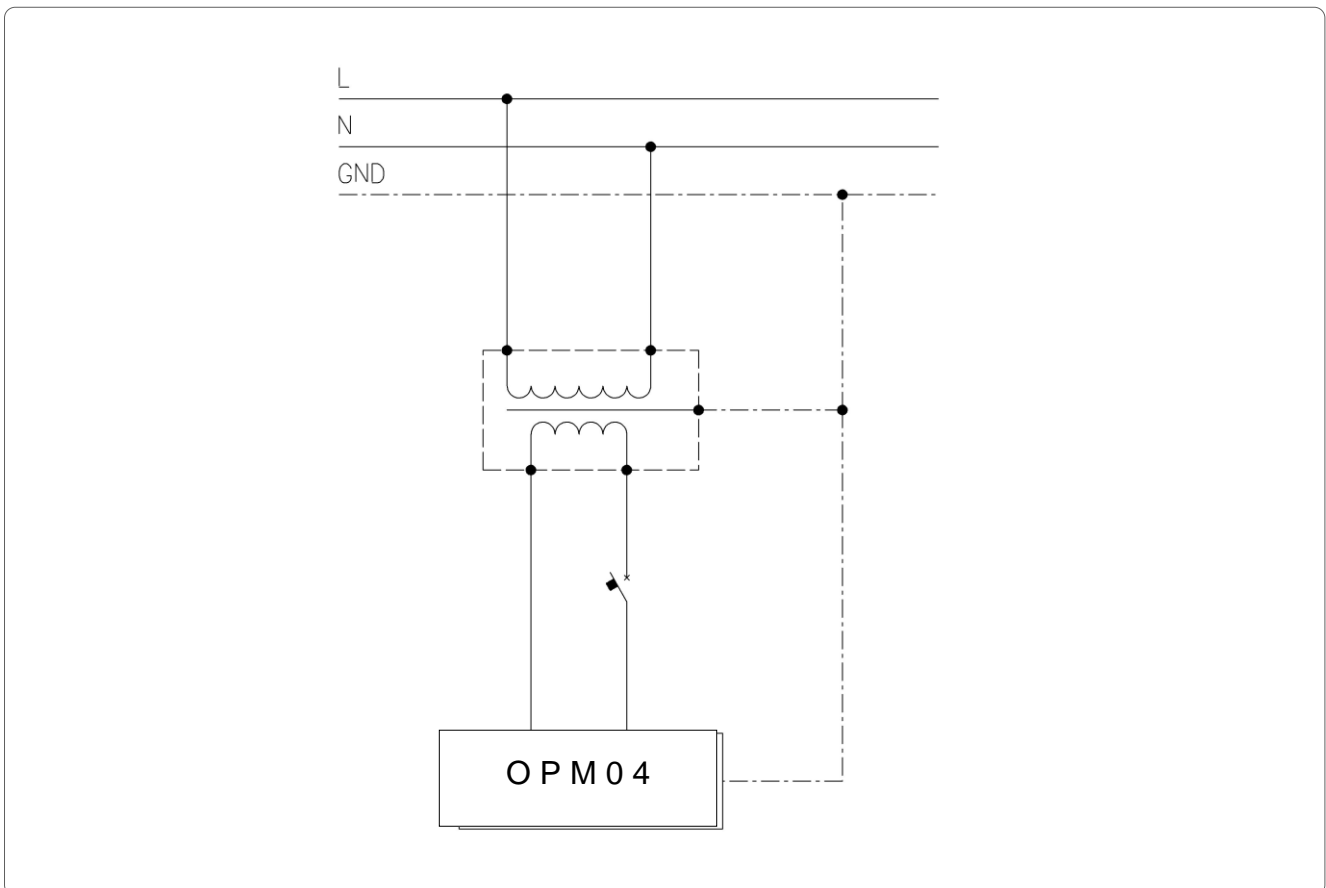

Fig. 8

4.5. Interface ports

The OPM04 is equipped with:

- 1 RS232C serial port
- 16 two-way 24Vdc inputs
- 8 two-way 24Vdc / 150mA outputs (resistive load)
- 16 input - 8 output expansion board option

The RS232C serial port is used for the communication between PC and OPM04.

The two-way inputs are used to acquire information in the form of electric signals. If the input is used as a revolution counter, it shall have a signal with a logic state over 550 μsec . (maximum speed that can be reached at 850 RPM). If it is used as a signal, it shall have a logic state over 20 msec for the inputs I02X and I06X; for the inputs I03X and I05X the entire byte is filtered, therefore the entire byte shall remain stable for 20msec.

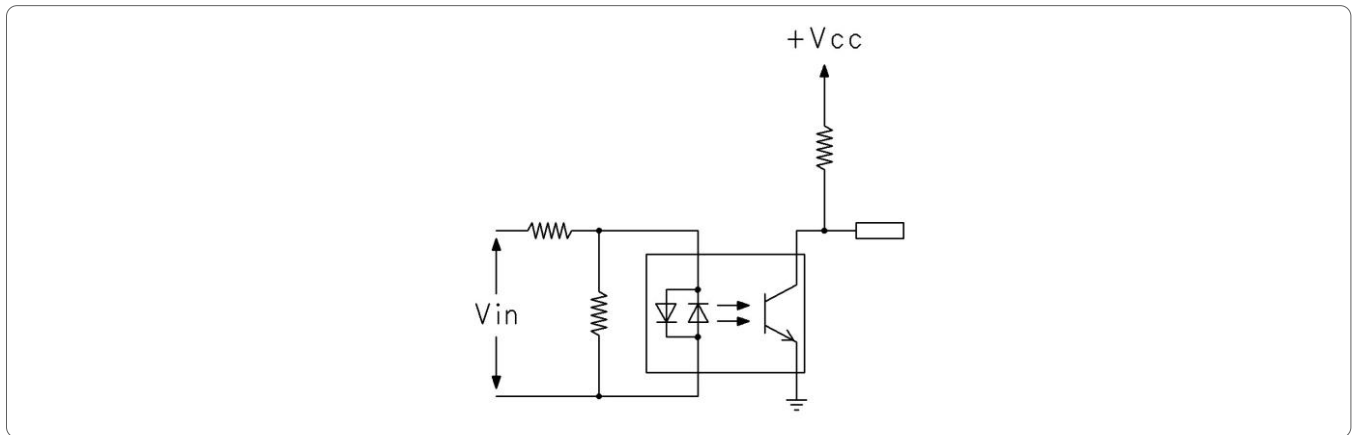

Fig. 9

The outputs are used to export information in the form of electric signals.

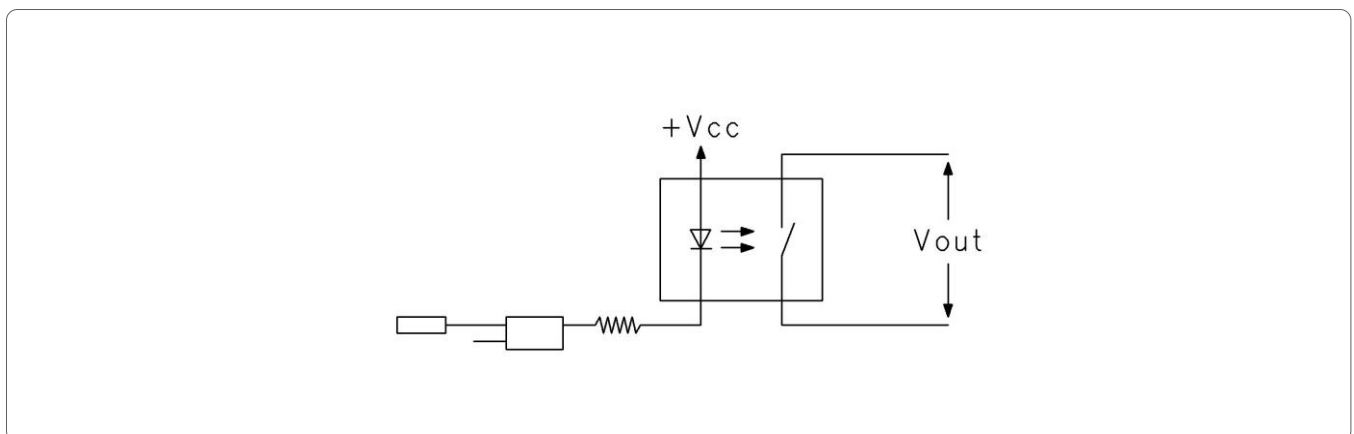

Fig. 10

4.6. Serial connection cable

The OPM04 is equipped with the following cable:

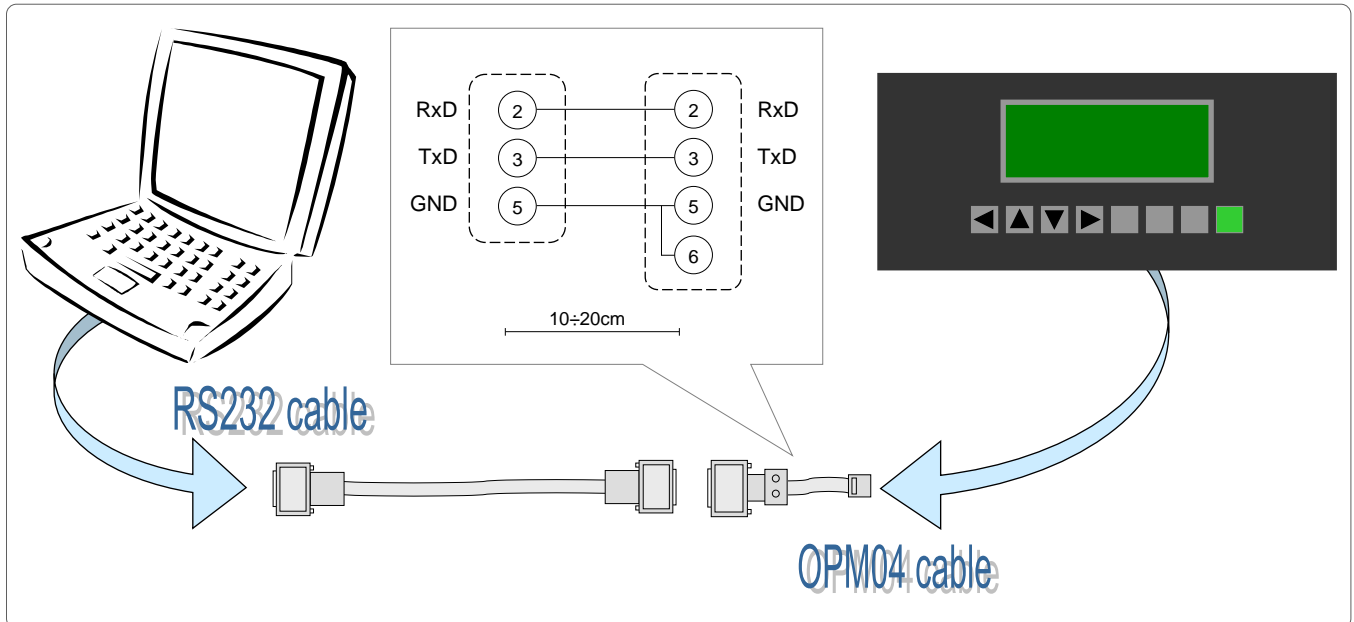

Fig. 11

4.7. Program updating

Please contact LOGOMAT S.r.l. to update the resident software (support.opm@logomat.it)

4.8. Failures

The following error messages can appear on the display:

1. **REPROGRAM MESSAGE !**
FLASH EPROM:
MISSING, EMPTY OR
DATA CORRUPTED

The message appears every time the program detects one of the following failures, when the display is switched on:

- Data Eprom missing.
- Data Eprom empty.
- Data Eprom corrupted.

2. KEY PRESSED:

The message indicates that, upon switching on, one of the keys is pressed. The key symbol will be displayed to indicate the pressed key: → ← ↑ ↓ - E M E

- →
- ←
- ↑
- ↓
- E for ESC
- M for menu.
- E for enter.

3. No messages:

If no message appears on the display check:

- the power supply.

4. "Data Transfer" display upon switching on:

If, upon switching on, the display automatically sets to Data Transfer without showing any message before, check if the "HELP" key is blocked in pressed position. It automatically sets to Data Transfer if the message EEPROM is missing, empty or faulty, or if the Data RAM is missing or faulty.

5. ZERO POWER MISSING:

It is displayed for a few seconds upon the switching on when the Data RAM is missing or faulty.

6. After a machine program transfer, the keyboard or the display are in fault. The transfer is aborted. Switch off the operator's panel and switch it on by holding the  key pressed. The wording "Data transfer" will be displayed. Now transfer the machine program again.