CODE READER DSO2



USER

MANUAL

Contents

Introduction 5

1. GENERAL DESCRIPTION OF HARDWARE.....	6
1.1. Components.....	6
1.2. Caratteristiche tecniche unità centrale DS02	7
1.3. Code reader wiring diagram.....	8
1.4. Connection TERMINAL ► DS02 ► DS2200.....	8
1.5. Front panel elements.....	9
1.6. Rear panel elements	9
1.7. Mounting and positioning the reading heads.....	10
2. DESCRIPTION OF THE SOFTWARE MENU	11
Front panel signals.....	11
Main	12
2.1. Setup	13
2.1.1 Head 1.....	14
2.1.1.1 Download	15
2.1.1.2 Bar optimization	16
2.1.1.2.1 Overflow.....	16
2.1.1.2.2 Percentage.....	17
2.1.1.3 Selection Code	18
2.1.1.4 Outputs setting	20
2.2. Programming.....	21
2.2.1 Select Head	22
2.2.2 Programming Code.....	23
2.2.2.1 Keyboard	24
2.2.2.2 Autoreset	25
2.2.2.2.1 Code Acquired.....	26
2.2.2.3 Memory	27
2.2.2.3.1 Memory read.....	28
2.2.2.3.2 Memory write.....	30
2.2.2.3.3 Memory delete	32
2.2.3 Current Format	34
2.2.4 Configuration.....	35
2.2.5 Shift Register	35
2.2.5.1 Shift Register 1.....	36
2.2.6 Consecutive	36
2.2.6.1 Errors 1= 0	37
2.3. Production	38
2.3.1 Single head	38
2.3.2 Multiple heads	39
2.3.3 Reset counters	40
2.4. Language	41
2.5. Programming examples.....	42

2.5.1	Head no.1 setup.....	42
2.5.2	Enabling reading head no.1	43
2.5.3	Code setting	44
2.5.4	Start of the production cycle.....	45

Introduction

In addition to being a practical guide for using the DS02 code reader, this manual also pinpoints the essential aspects of the equipment.

DS02 is a compact code reader able to verify the read code. An independent CPU for each reading channel makes for extremely fast, reliable code reading.

The reading heads are connected to the equipment by RJ45 connectors. Connection to the machine is via 10- and 12-pole industrial connectors. The equipment provides the voltage values required for operation of the reading heads.

1. GENERAL DESCRIPTION OF HARDWARE

1.1. Components

CODE	DESCRIPTION
24401011	DS02 CODE READER TERMINAL
24401010	PROGRAMMED DATALOGIC DS2200 LASER SCANNER HEAD
24402024	5 MT EXTENSION CABLE FOR DS2200 SCANNER (RJ45 - DB25 CONNECTORS)
24402025	7 MT EXTENSION CABLE FOR DS2200 SCANNER (RJ45 - DB25 CONNECTORS)
24402026	10 MT EXTENSION CABLE FOR DS2200 SCANNER (RJ45 - DB25 CONNECTORS)

1.2. Caratteristiche tecniche unità centrale DS02

The reading heads are connected to the equipment by RJ45 connectors.
Connection to the machine is via 10- and 12-pole industrial connectors

Specifications:			
Mechanical	Dimension	96x96x100mm	
	Housing	Shielded	
Electrical	Power supply	24Vdc	With metallic isolation
	Absorption	10Watt	
	Reading head power unit	12Vdc/5Vdc	
	Inputs	N° 4 24VDC	With optoisolation
	Outputs	N° 4 24VDC	With optoisolation
	I/O display	By means of diodes on the front panel	
	Interface with Host	RS232 C	
Optical			Reading distance
	Laser	Static or moving code reading	Da 45 a 70mm
	Code length	Max. 50mm	
	Number of bars	Max. 12	
Miscellaneous	Display	16 digits x 4 lines alphanumeric display	
	Check speed	Max. 100m/min	
	Programming	Self-learning Code entering through keyboard Code entering from memory	
	Codes that can be checked	DS2200	
		See <i>Enclosure A</i>	

1.3. Code reader wiring diagram

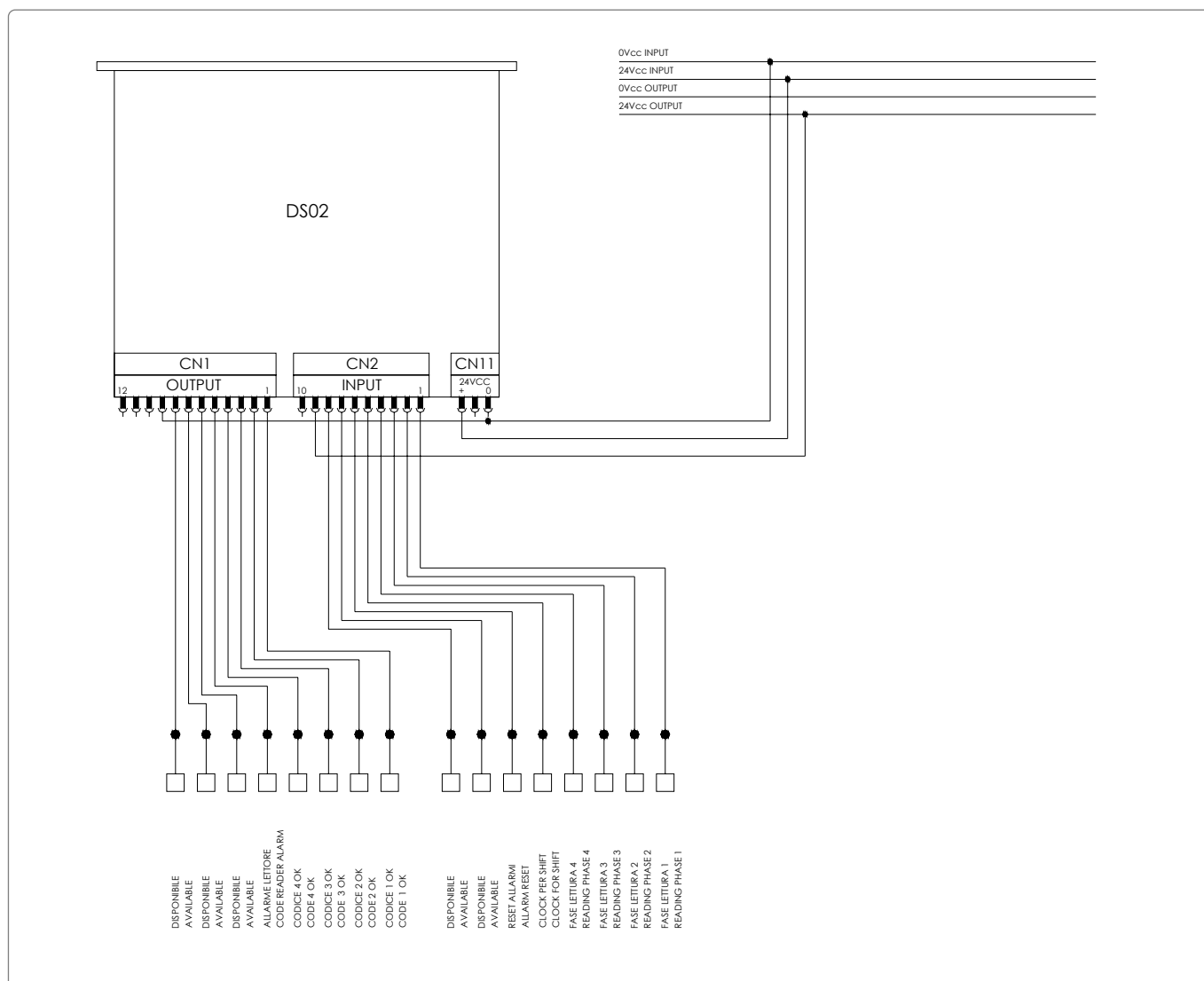

1.4. Connection TERMINAL ► DS02 ► DS2200

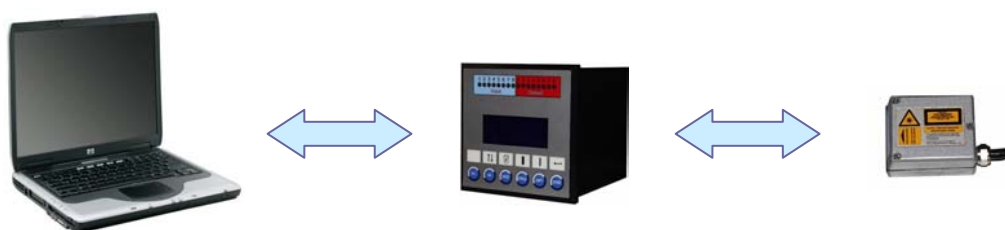

1.5. Front panel elements

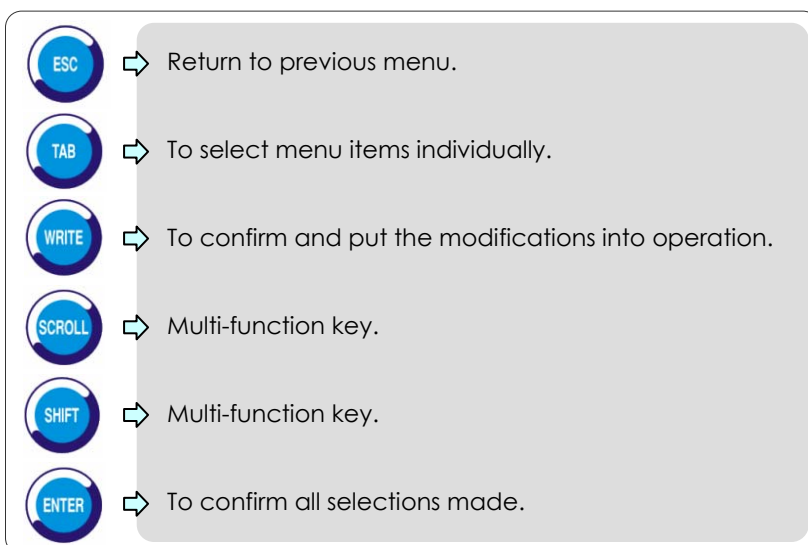
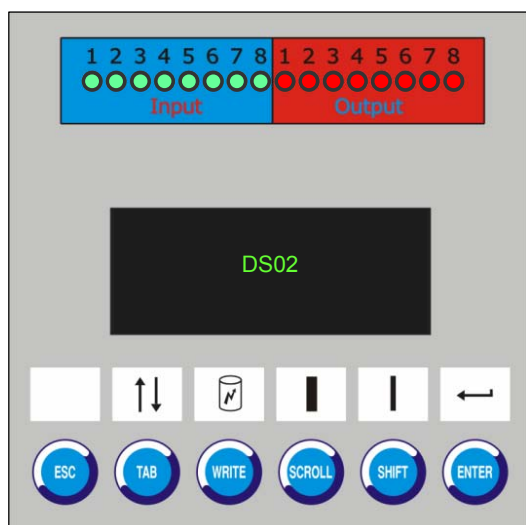

1.6. Rear panel elements

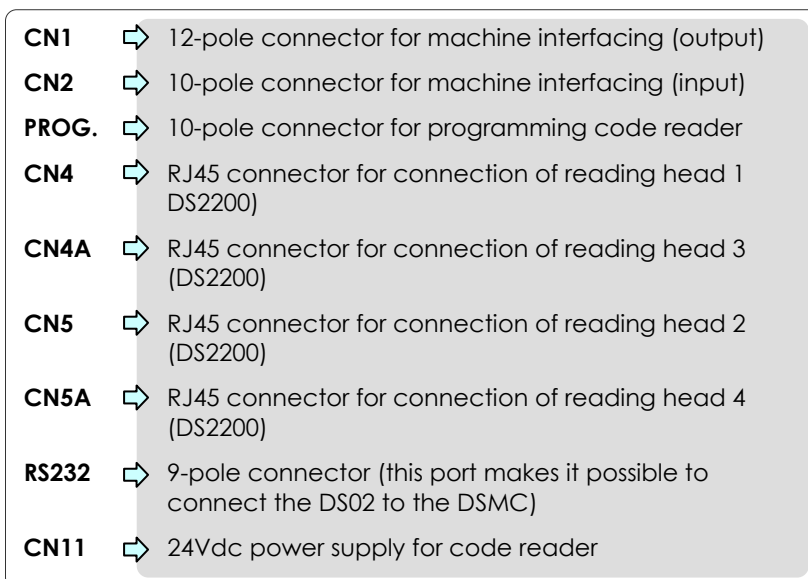

1.7. Mounting and positioning the reading heads

Place the reading head at a distance of about 70mm from the code reading position. If the code is too glossy, the reading head can be inclined by 15°.

For further information, consult the enclosed Datalogic manual.

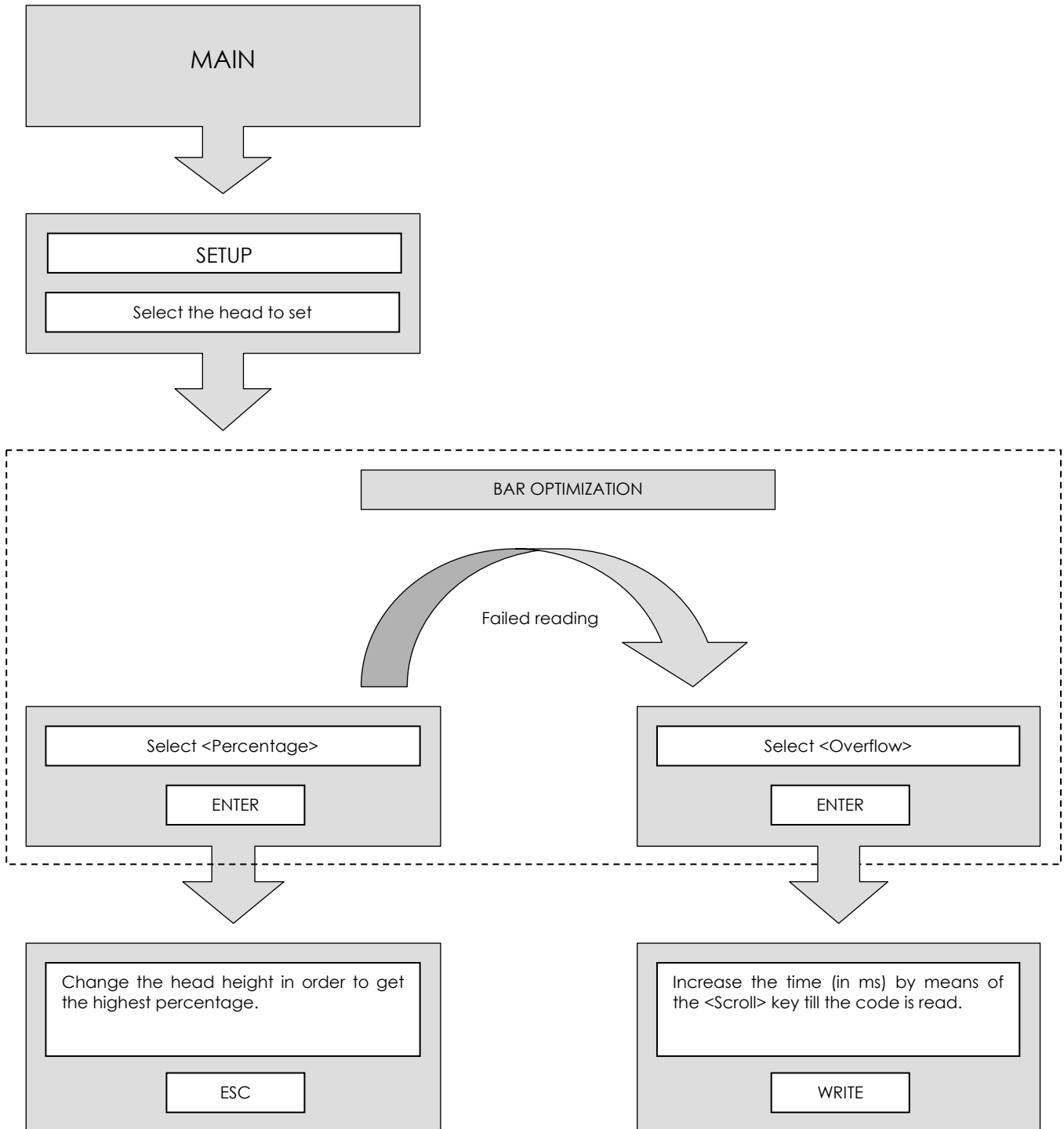

2. DESCRIPTION OF THE SOFTWARE MENU

The program supplied with the equipment enables the following operations:

- display and monitoring of 4 codes at a time
- separate enabling and disabling of the code reading

Upon start-up, the following operations are automatically carried out:

- display of the installed software version
- loading from EEPROM of the code values used during latest production
- display of the production menu

Front panel signals

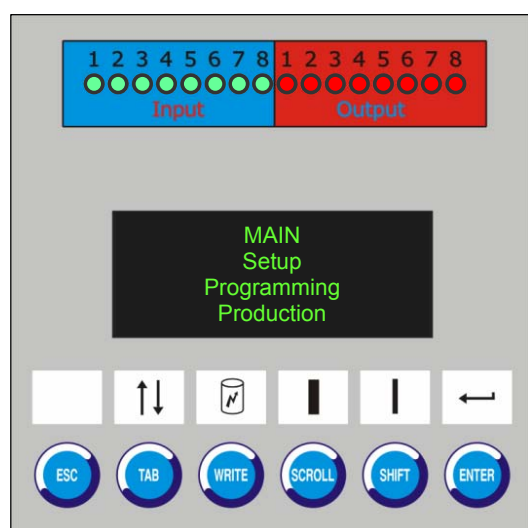

Input LEDs



- 1 Head 1 reading phase
- 2 Head 2 reading phase
- 3 Head 3 reading phase
- 4 Head 4 reading phase
- 5 Clock shift register
- 6 Reset for consecutive errors
- 7 Available
- 8 Available

Output LEDs

- 1 Head 1 reading OK signal
- 2 Head 2 reading OK signal
- 3 Head 3 reading OK signal
- 4 Head 4 reading OK signal
- 5 Code reader general alarm
- 6 Available
- 7 Available
- 8 Available

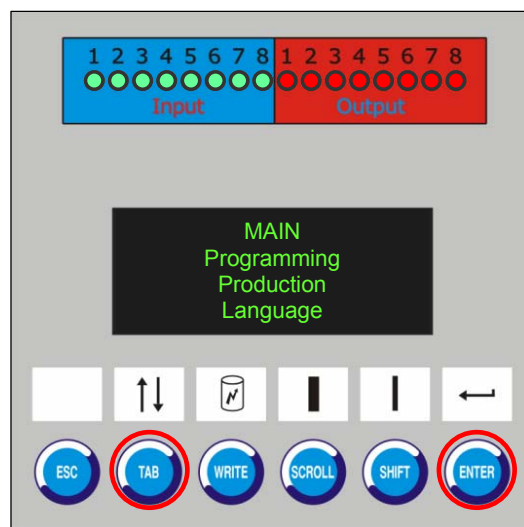
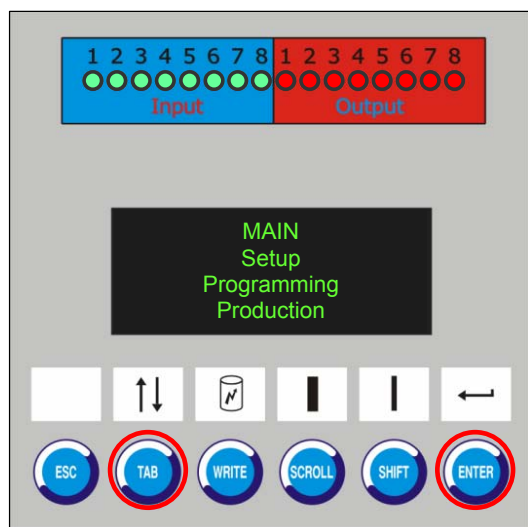
Main



	➔ To select one of the four menus shown.
	➔ To confirm the selection made and to enable the relevant menu.

- Setup, for optimising location of reading heads.
- Programming, displays the programming menu, thus enabling and programming the reading heads.
- Production, monitors effected production, including display of read codes. The exit from this menu is password-protected.
- Language, for selecting the on-display language.

PASSWORD: **ESC + ESC + ESC + SCROLL + SHIFT + WRITE**

2.1. Setup

To access this page, select command <Setup> from the MAIN menu.
With this menu you can optimized the location of the reading heads.

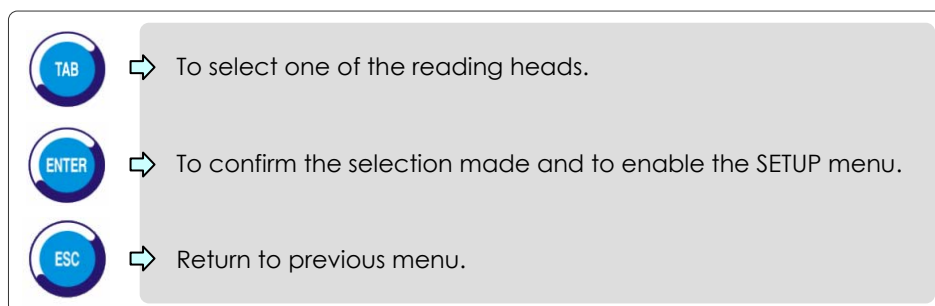
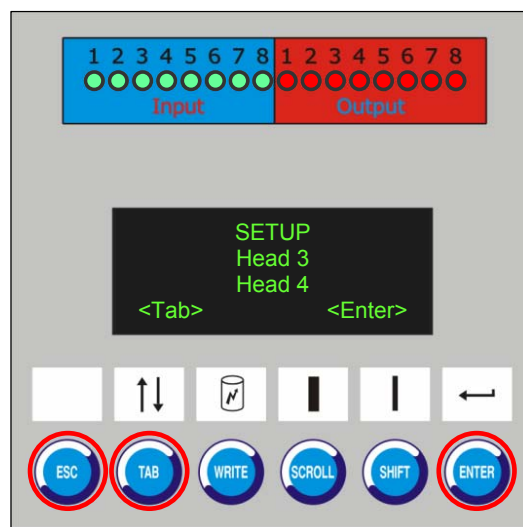
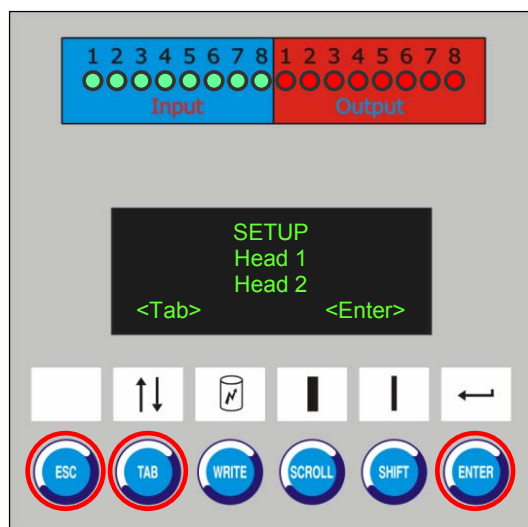



By selecting one of the reading heads, you can optimise the mechanical location of the head on the machine.

2.1.1 Head 1

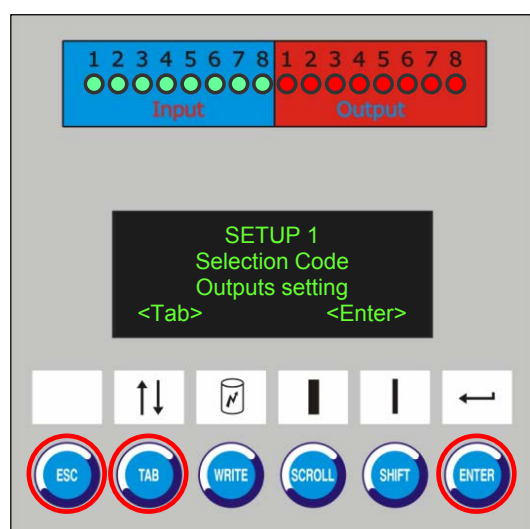
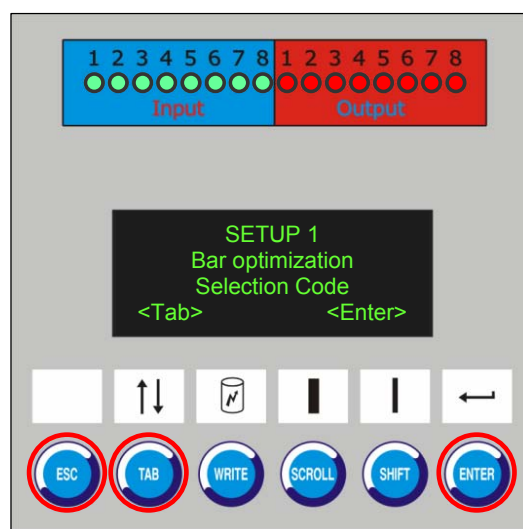
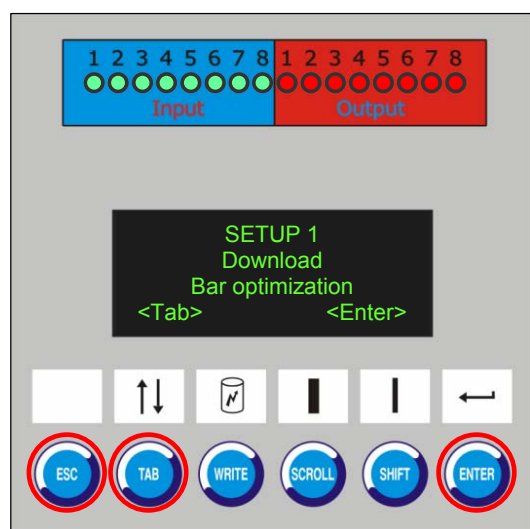
A questa pagina si accede selezionando il comando <Testa 1> dal menù MESSA A PUNTO.



	⇒ To select one of the items shown.
	⇒ To confirm the selection made and to enable the relevant menu.
	⇒ Return to previous menu.

2.1.1.1 Download

To access this page, select command <Download> from the SETUP 1 menu.

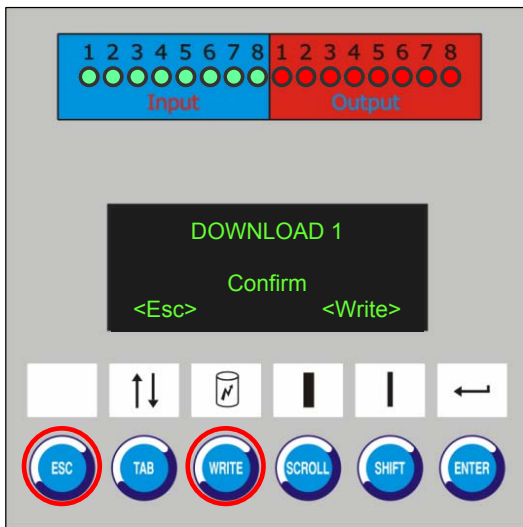

Downloading is only done if using a new reading head.

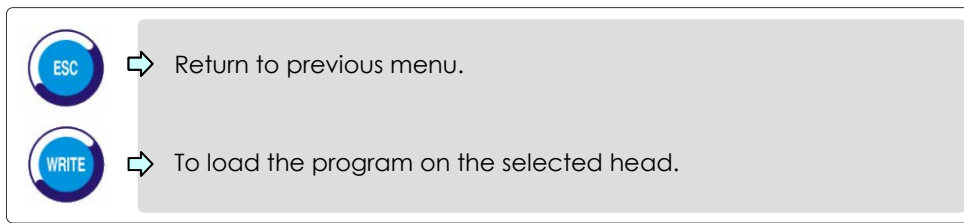

The following screen appears during the download. When the download has finished, you return to the SETUP 1 menu.

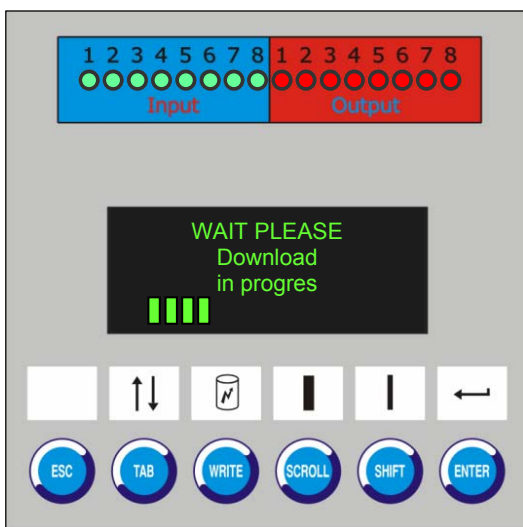

2.1.1.2 Bar optimization

To access this page, select command <Bar optimization> from the SETUP menu.

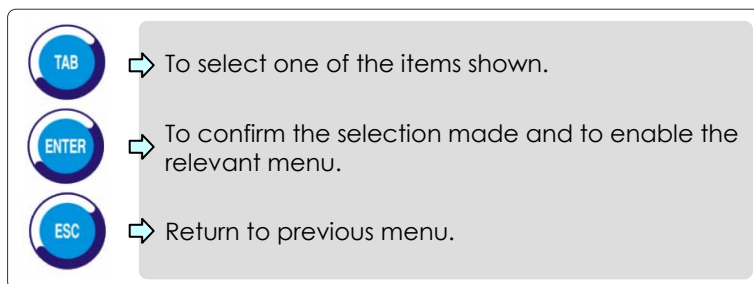
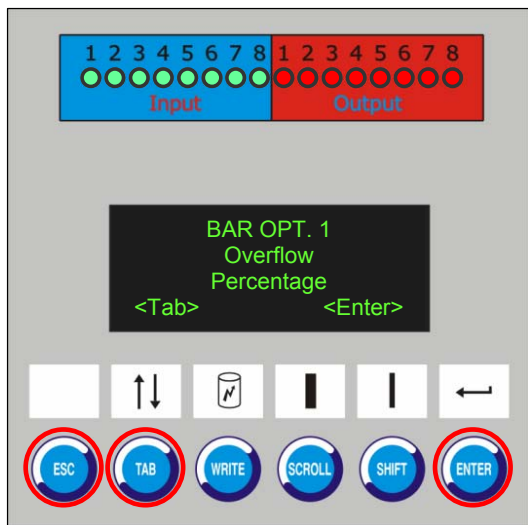

Overflow, for optimising code reading depending on bar width and the breadth of the first white interval ahead of the initial bar.

Percentage, displays reading precision of the code as a percentage. The higher it is, the better the precision. You should adjust the distance of the reading heads according to precision.

2.1.1.2.1 Overflow

To access this page, select command <Overflow> from the BAR OPT.1 menu.

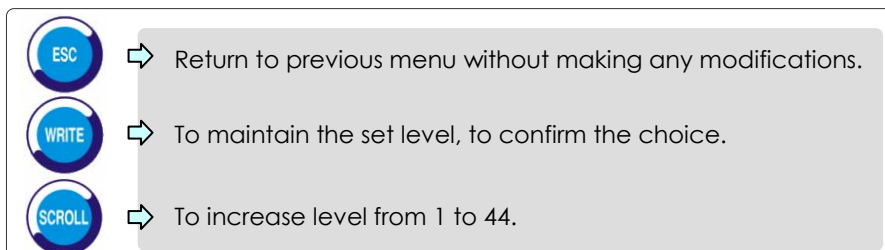
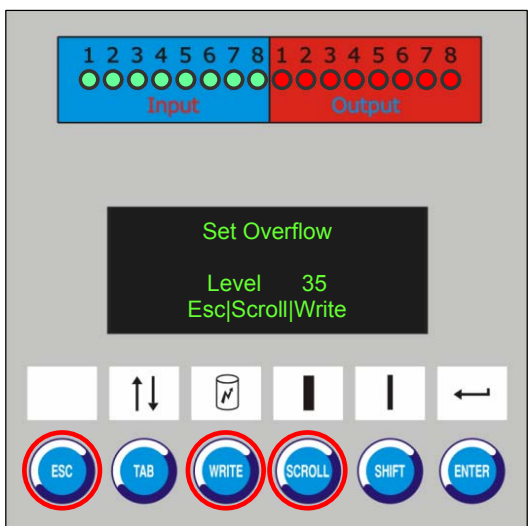

2.1.1.2.2 Percentage

To access this page, select command <Percentage> from the BAR OPT. 1 menu.

This menu displays reading precision of the code as a percentage. The higher it is, the better the precision. You should adjust the distance of the reading heads according to precision.

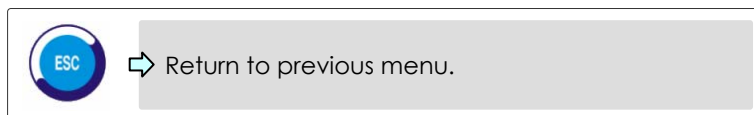
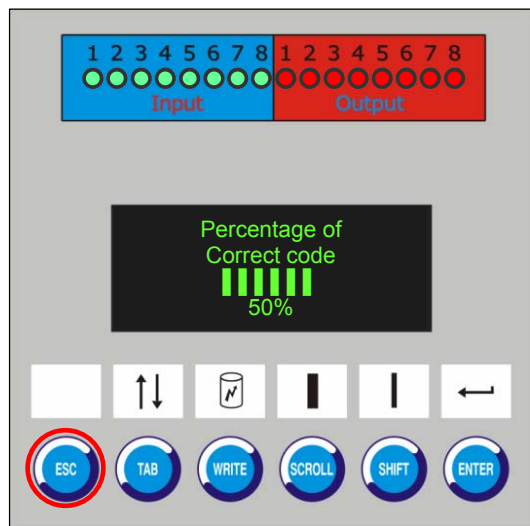



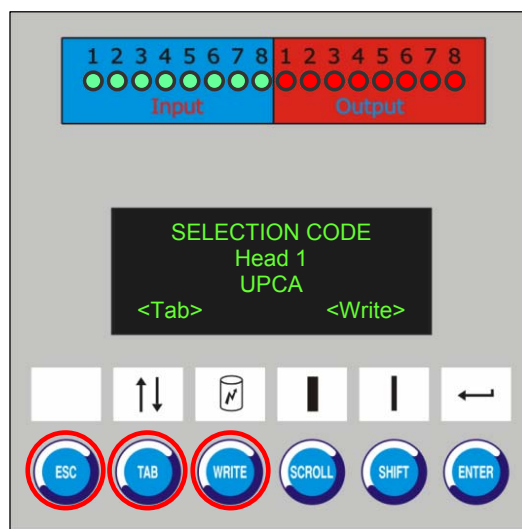
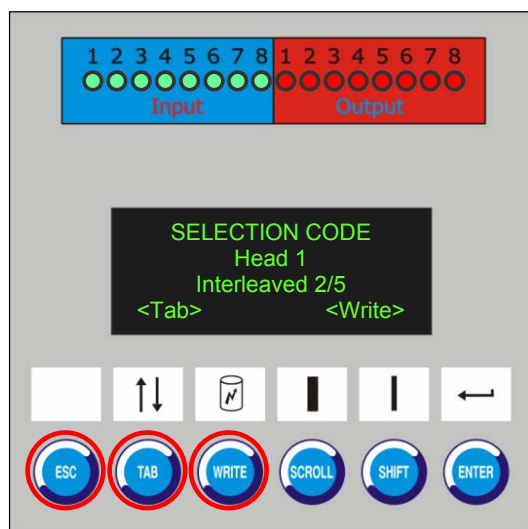
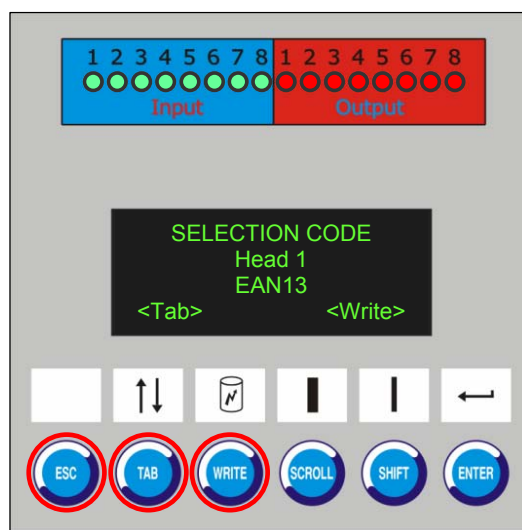
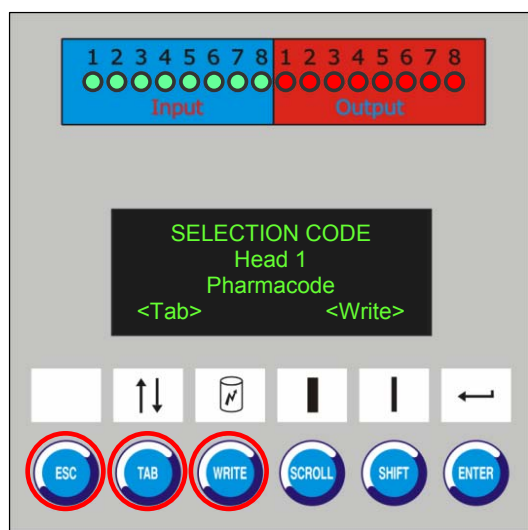

2.1.1.3 Selection Code

To access this page, select command <Selection Code> from the SETUP1 menu.

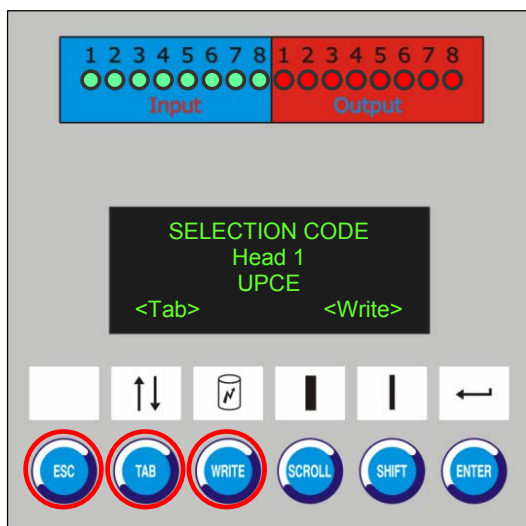
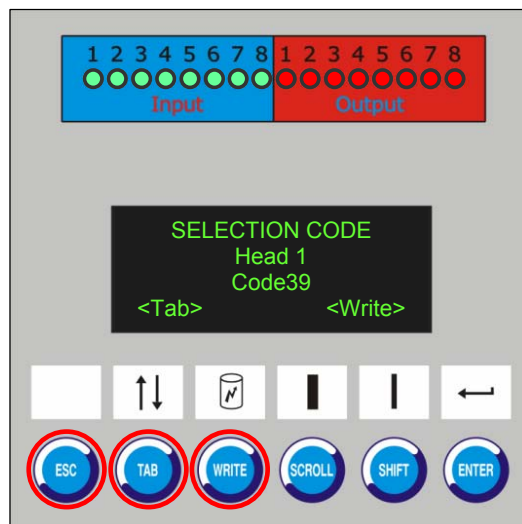
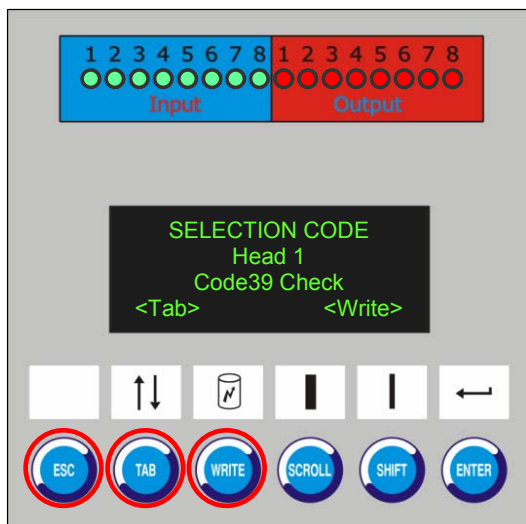
This menu is used to set the code type which has to be recognized by the reading head.





-  → To display the code type to be recognized.
-  → To confirm the set code, returning to the previous menu.
-  → Return to previous menu.

2.1.1.4 Outputs setting

To access this page, select command <Outputs setting > from the SETUP 1 menu.

This menu is used to set the time of the head reading OK signal.

If the reading time is set to 0 msec, the head reading OK signal lasts till the reading phase of the next head.

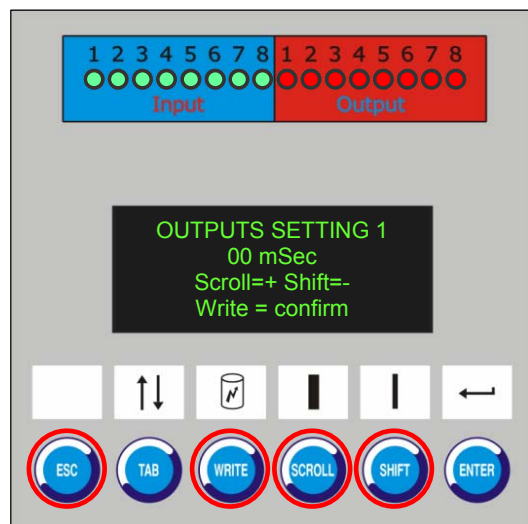

The OK signal time can be set from 0 to 524 mSec.

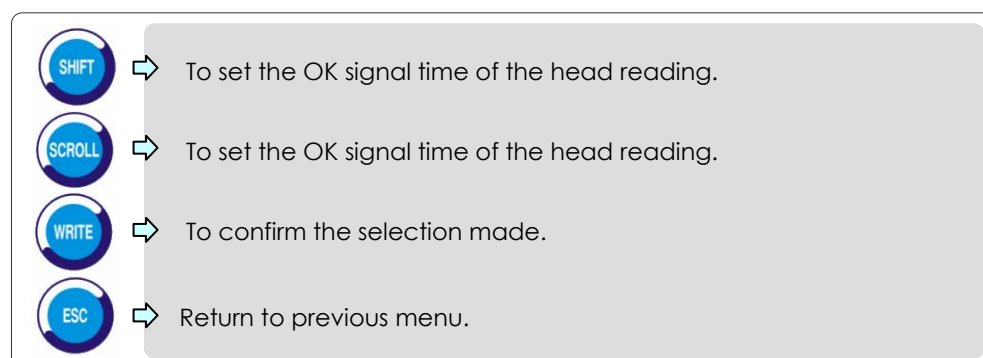



2.2. Programming

To access this page, select command <Programming> from the MAIN menu.

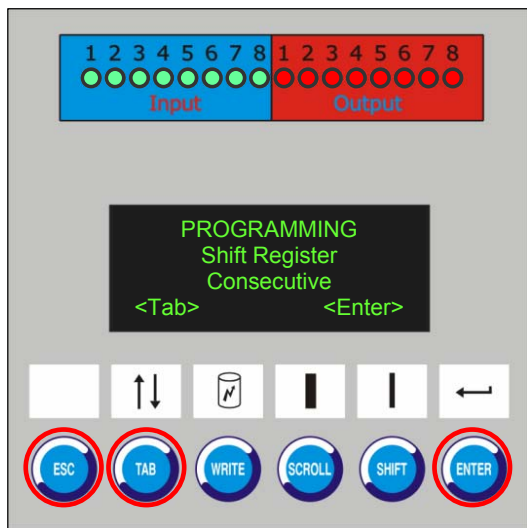
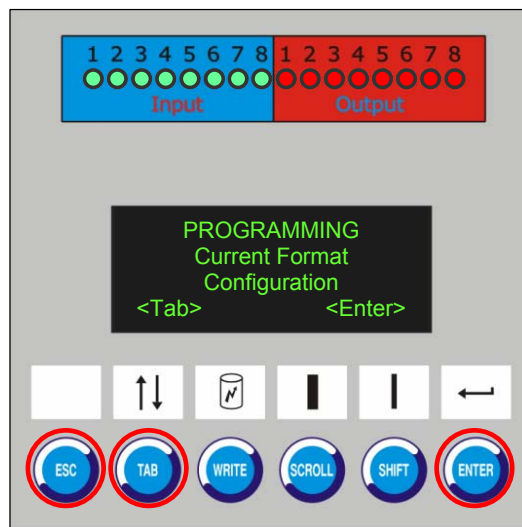
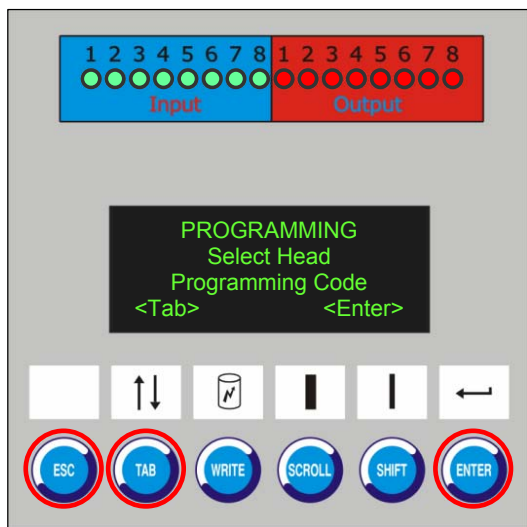
This menu is used for enabling and programming the reading heads.





	⇒ To select one of the items shown.
	⇒ To confirm the selection made and to enable the relevant menu.
	⇒ Return to previous menu.

2.2.1 Select Head

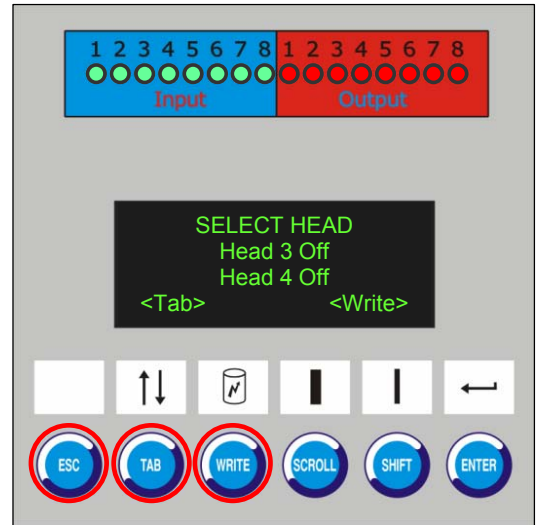
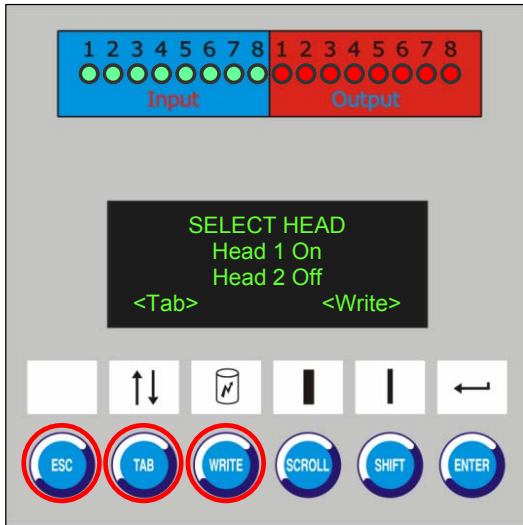
To access this page, select command <Select Head> from the PROGRAMMING menu.







	⇒ To select the reading head to be enabled or disabled.
	⇒ To change the enabling status (ON - OFF) of the reading head.
	⇒ Return to previous menu, maintaining the set status.

By pressing the Write key, the status of the reading head changes. If it was ON, it changes to OFF and vice versa. When the head is OFF, the relevant output is on level 1 (reading head OFF). The PLC will always receive the OK code signal.

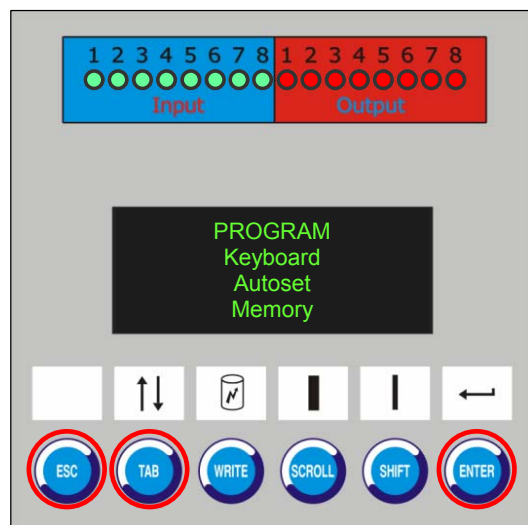
2.2.2 Programming Code

To access this page, select command <Programming Code> from the PROGRAMMING menu.







-  ⇒ To select one of the items shown.
-  ⇒ To confirm the selection made and to enable the relevant menu.
-  ⇒ Return to previous menu.

2.2.2.1 Keyboard

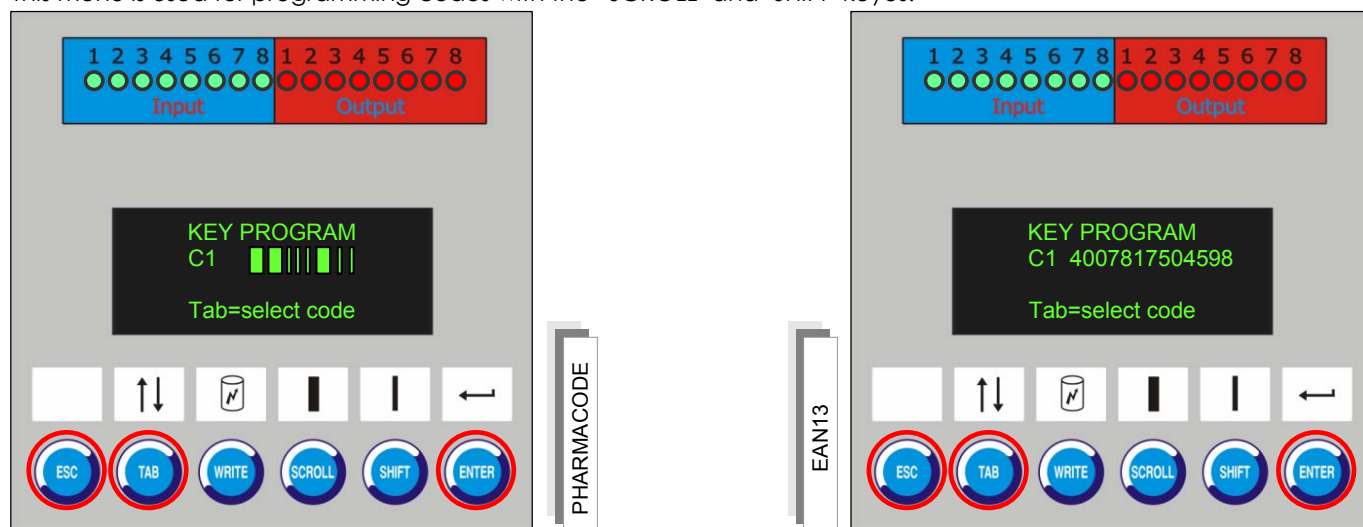

To access this page, select comand <Keyboard> from the PROGRAM menu.

This menu is used for programming codes with the "SCROLL" and "SHIFT" keys.

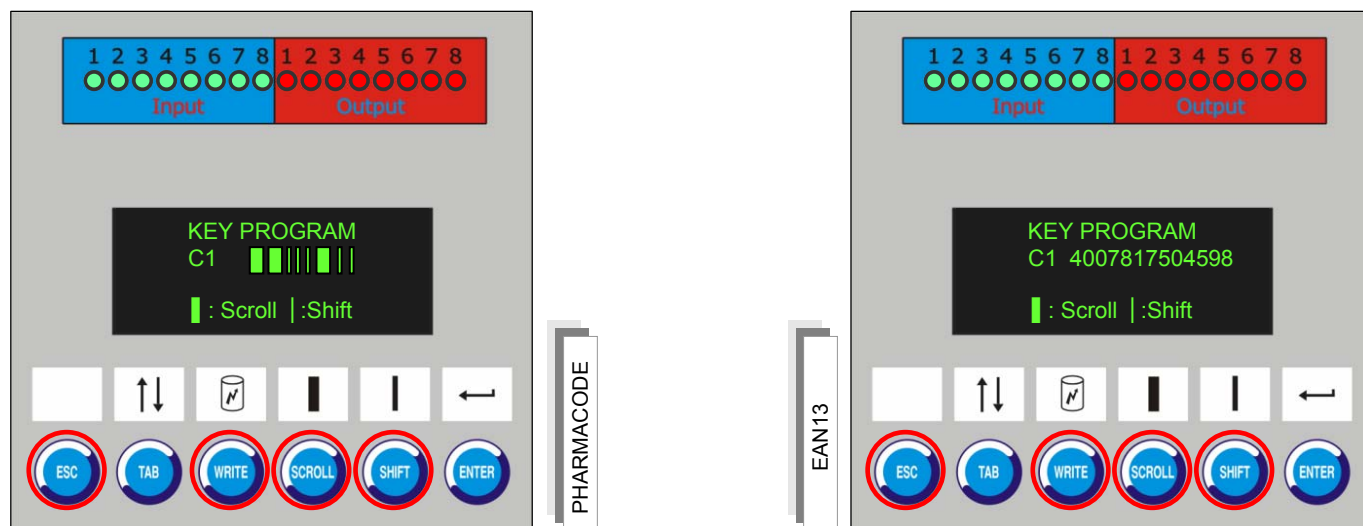

-  ⇒ Consente di visualizzare singolarmente il codice di ogni testa di lettura, oppure, in caso di testa non collegata, lo stato OFF.
-  ⇒ Abilita i tasti "SCROLL" e "SHIFT".
-  ⇒ Si torna al menù precedente.







-  ⇒ To enter the large bar in the code.
-  ⇒ To enter the thin bar in the code.
-  ⇒ To confirm the set code, returning to the previous menu.

2.2.2.2 Autoset

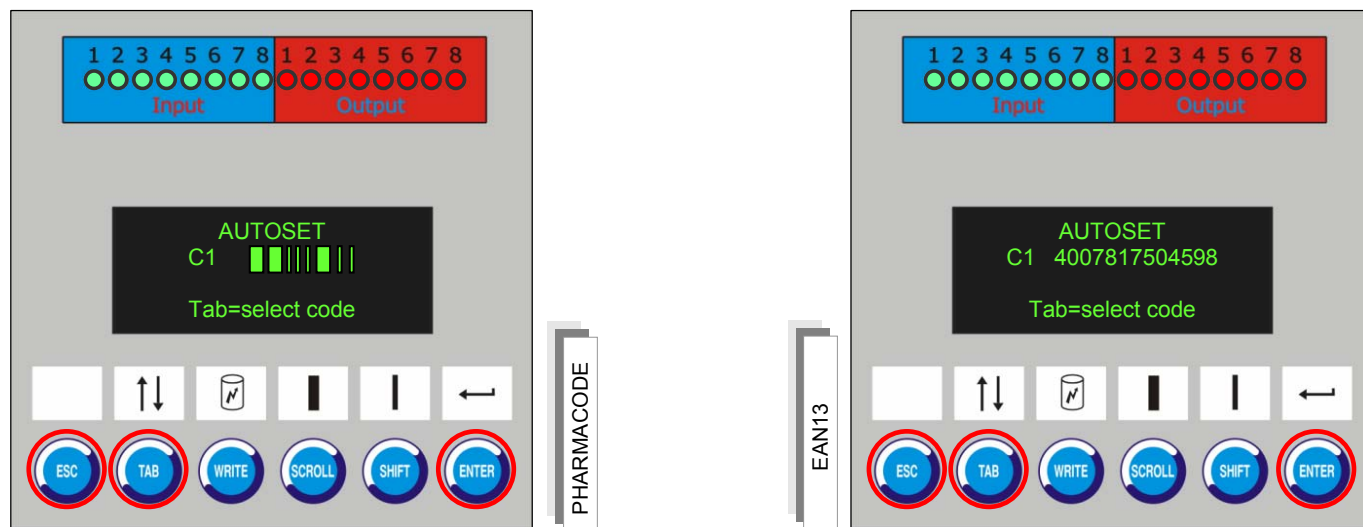
To access this page, select command < Autoset> from the PROGRAM menu.



By positioning a code in front of the reading head, this menu enables you to automatically acquire the read code.

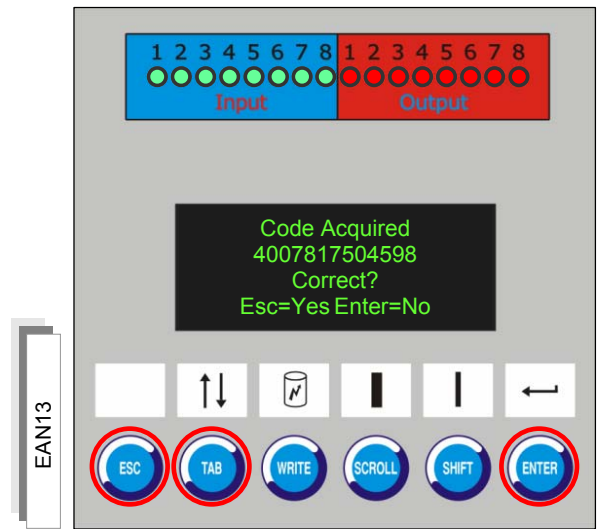
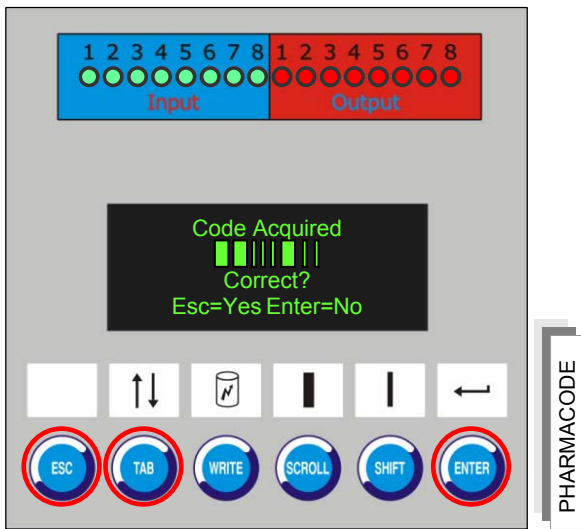

-  → To individually display the code of each reading head, or, if the head is not connected, the OFF status.
-  → To read the code.
-  → Return to previous menu.

2.2.2.2.1 Code Acquired



 → To read the read code.
 → To save the last code read, displaying the following menu.

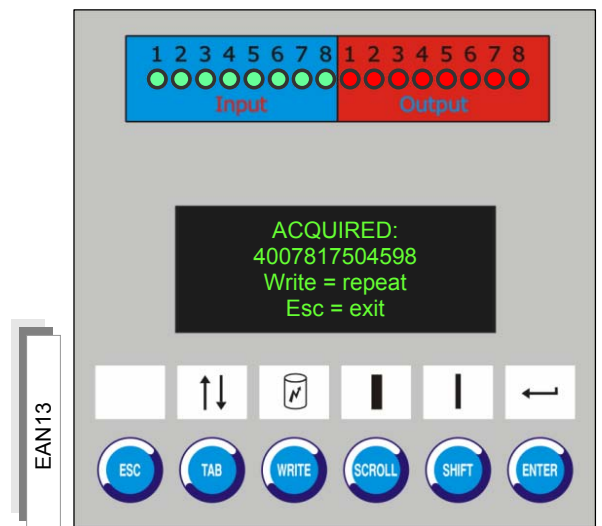
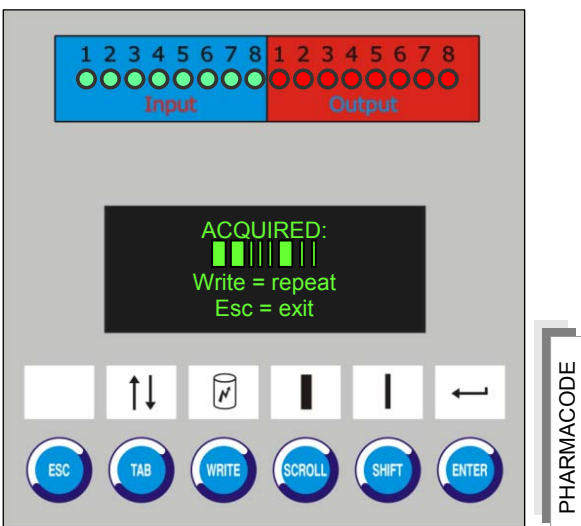

2.2.2.3 Memory

To access this page, select command < Memory > from the PROGRAM menu.

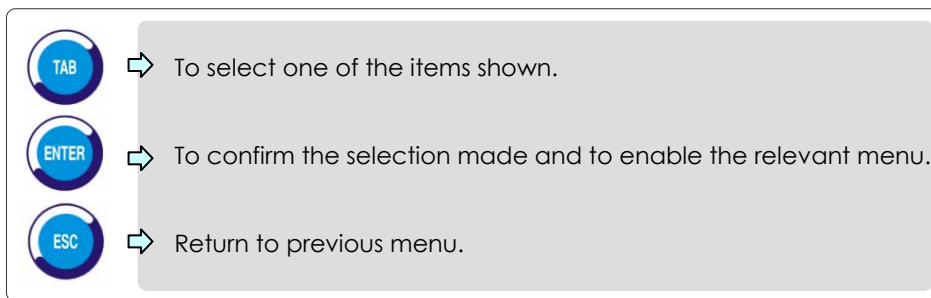
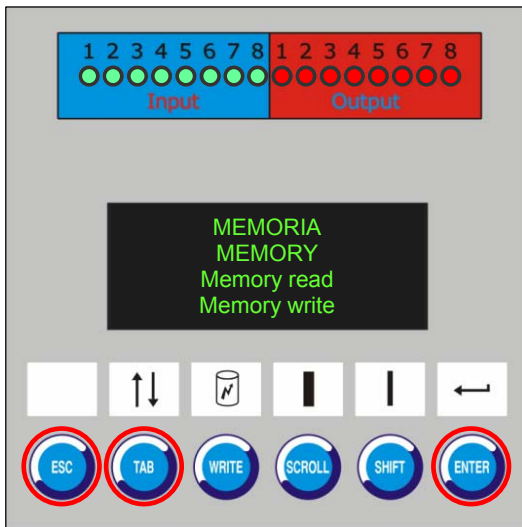

Memory read, for loading, as a current code to be verified, a format from the non-volatile EEPROM memory.

Memory write, for saving the current code to be verified in a format from the non-volatile EEPROM memory.

Memory delete for deleting a format from the non-volatile EEPROM memory.

2.2.2.3.1 Memory read

To access this page, select command <Memory read> from the MEMORY menu.

It is used for loading, as a current code to be verified, a format from the non-volatile EEPROM memory.

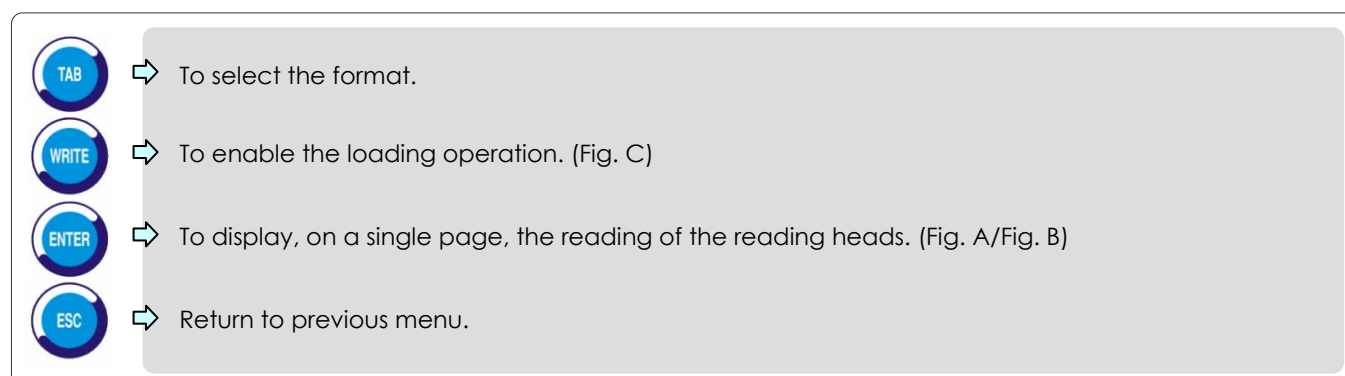
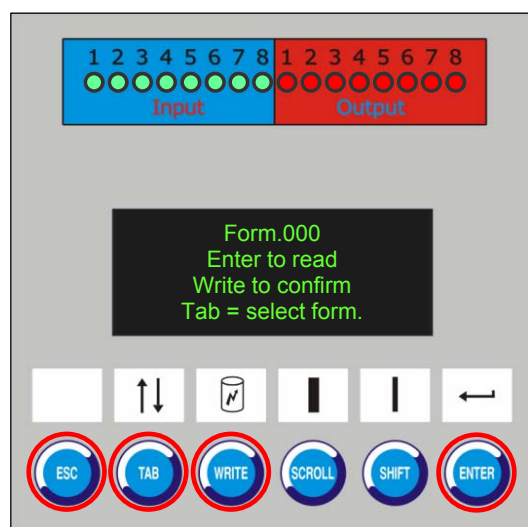

<Enter>

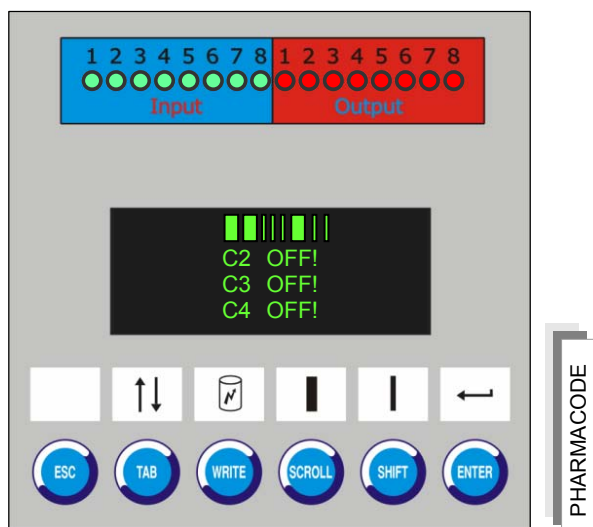

(Fig. A)

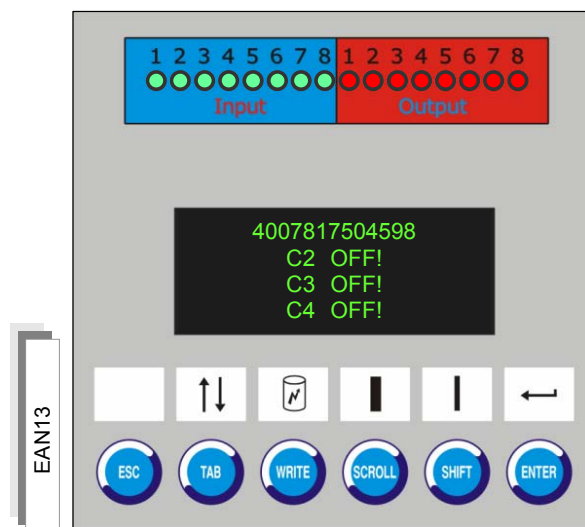

(Fig. B)

By pressing <Tab> the following settings can be displayed:

- SHIFT
- CONSECUTIVE ERRORS
- CODE TYPE TO BE READ BY THE HEAD

<Write>

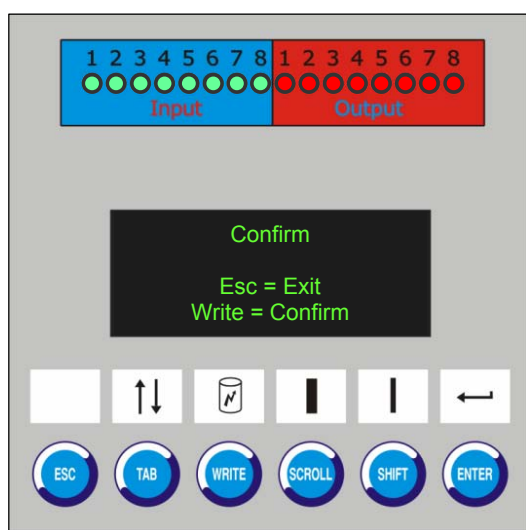





(Fig. C)

2.2.2.3.2 Memory write

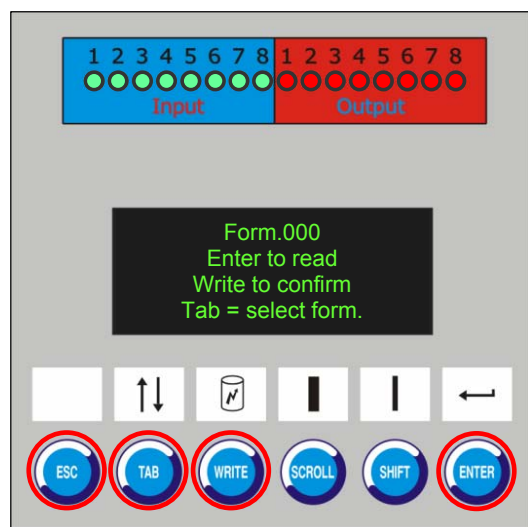
To access this page, select command <Memory write> from the MEMORY menu.

It is used for saving the current code to be verified in a format from the non-volatile EEPROM memory.



-  ⇒ To select the format.
-  ⇒ To enable the saving operation. (Fig. D / Fig. E)
-  ⇒ To display, on a single page, the reading of the reading heads. (Fig. F)
-  ⇒ Return to previous menu.

<Enter>

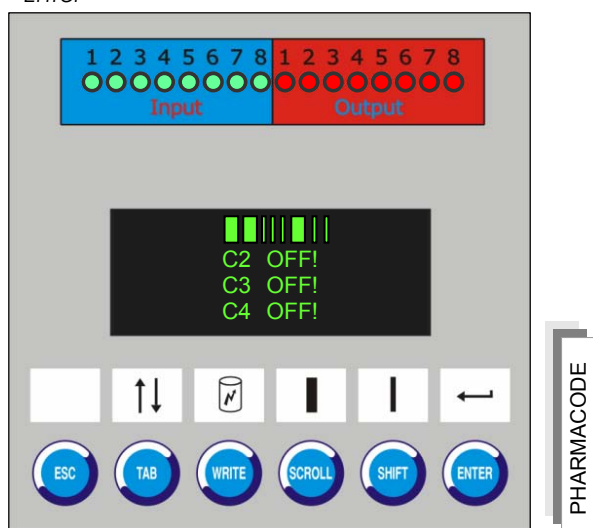

(Fig. D)

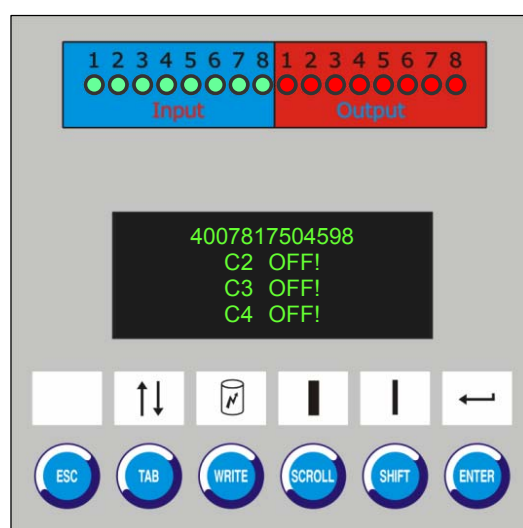

(Fig. E)

By pressing <Tab> the following settings can be displayed:

- SHIFT
- CONSECUTIVE ERRORS
- CODE TYPE TO BE READ BY THE HEAD

<Write>

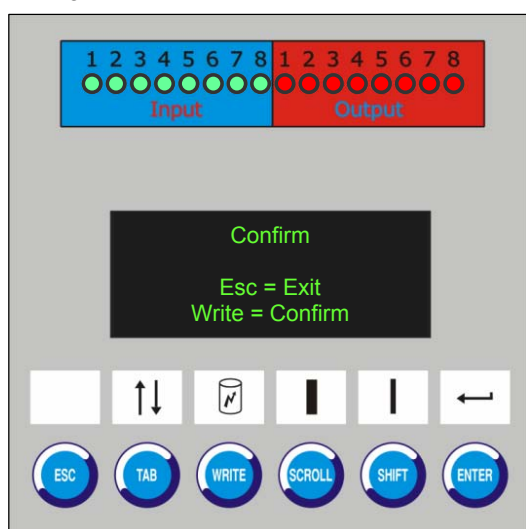





(Fig. F)

2.2.2.3.3 Memory delete

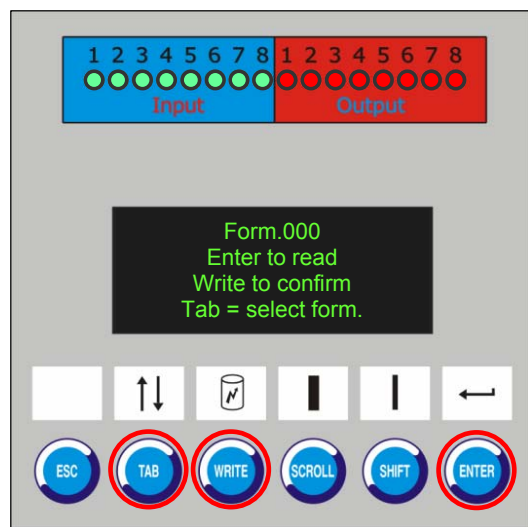
To access this page, select command <Memory delete> from the MEMORY menu.

It is used for deleting a format from the non-volatile EEPROM memory.



-  ⇒ To select the format.
-  ⇒ To enable the deleting operation. (Fig. G / Fig. H)
-  ⇒ To confirm the selection made and to enable the relevant menu. (Fig. I)
-  ⇒ Return to previous menu.

<Enter>

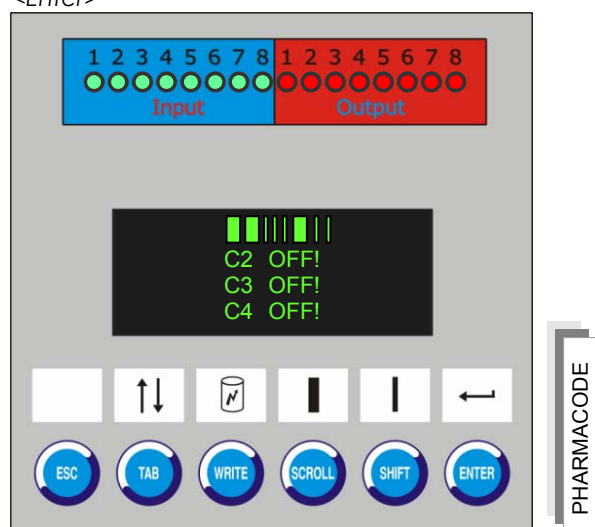

(Fig. G)

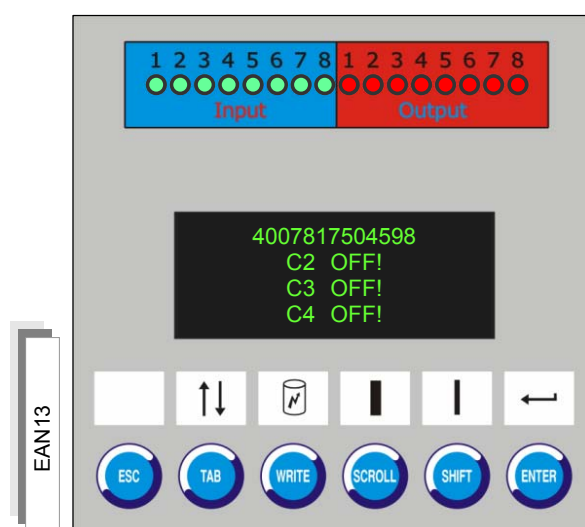

(Fig. H)

By pressing <Tab> the following settings can be displayed:

- SHIFT
- CONSECUTIVE ERRORS
- CODE TYPE TO BE READ BY THE HEAD

<Write>

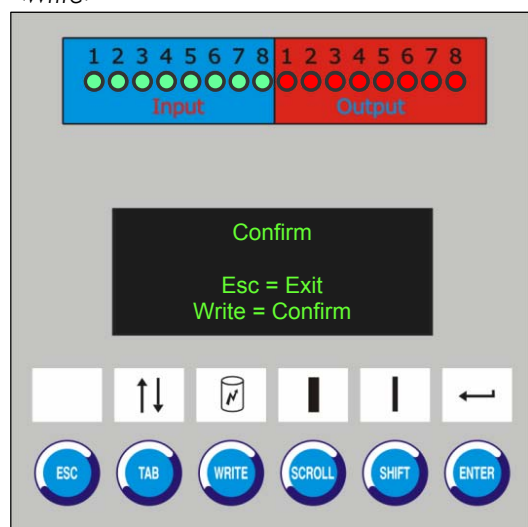

(Fig. I)

2.2.3 Current Format

To access this page, select command <Current format> from the PROGRAMMING menu.

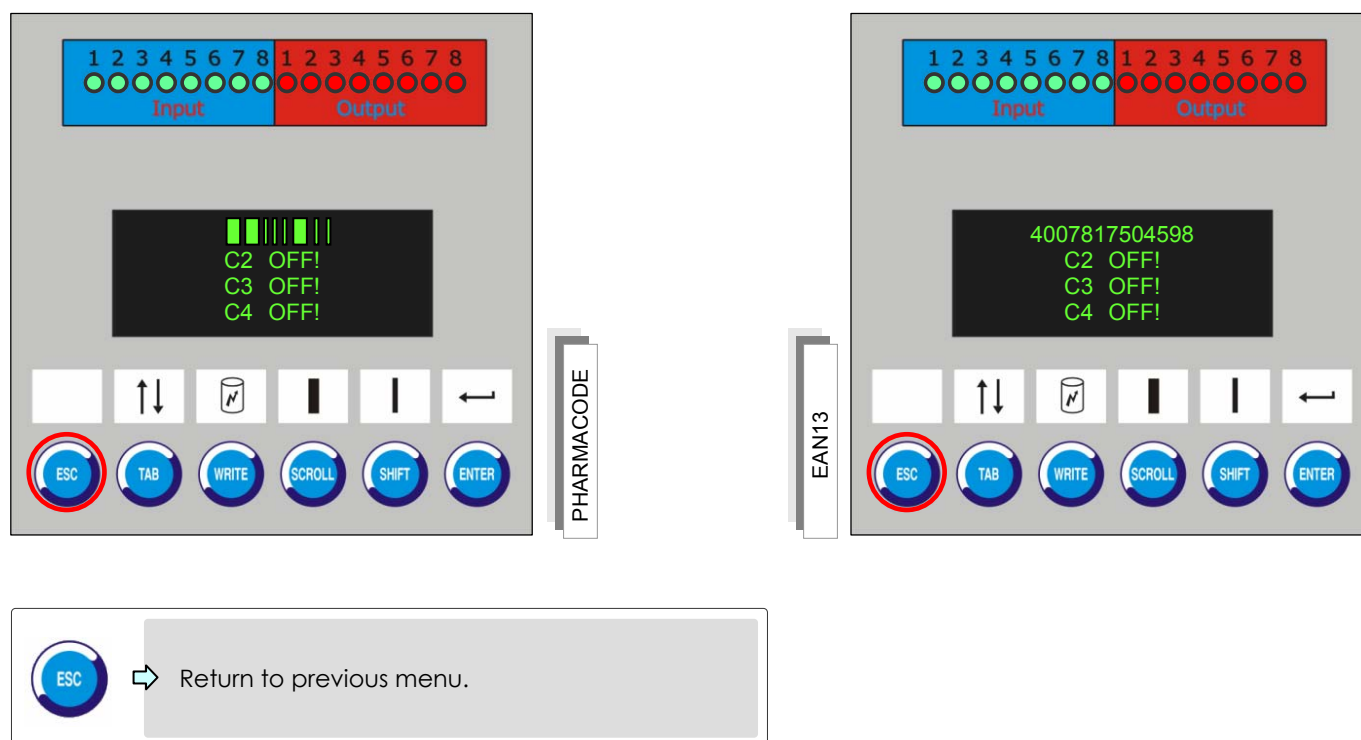

By pressing <Tab> the following settings can be displayed:

- SHIFT
- CONSECUTIVE ERRORS
- CODE TYPE TO BE READ BY THE HEAD

2.2.4 Configuration

To access this page, select command <Configuration> from the PROGRAMMING menu.
 This menu is used for displaying the location and type of the connected reading head.

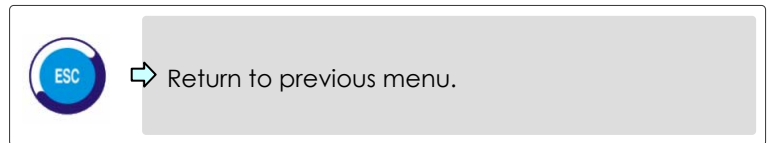
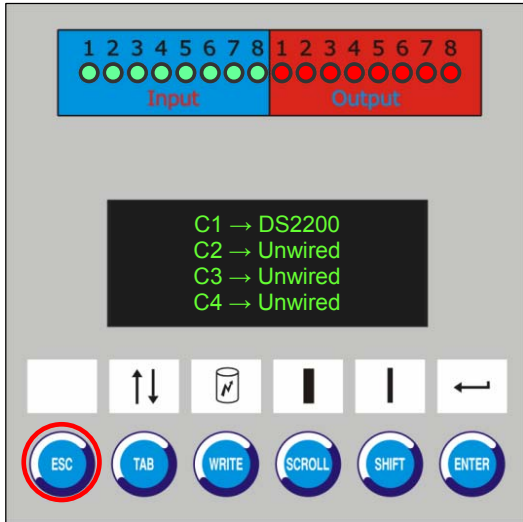

2.2.5 Shift Register

To access this page, select command <Shift Register> from the PROGRAMMING menu.
 This menu is used to program the shift steps.

The OK signal is shifted by means of the machine clock of a step number which corresponds to the set value. If 0 is set, the output is immediately updated, therefore the shift is disabled.

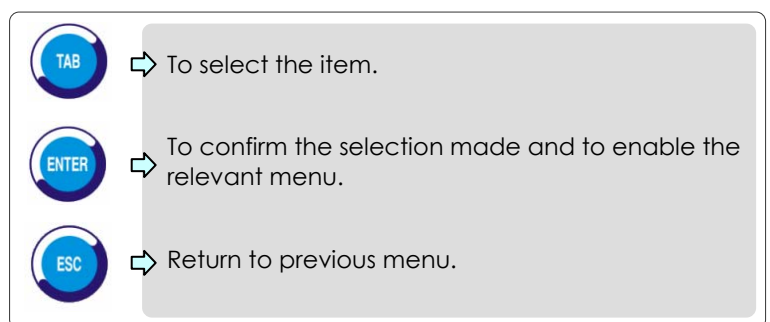
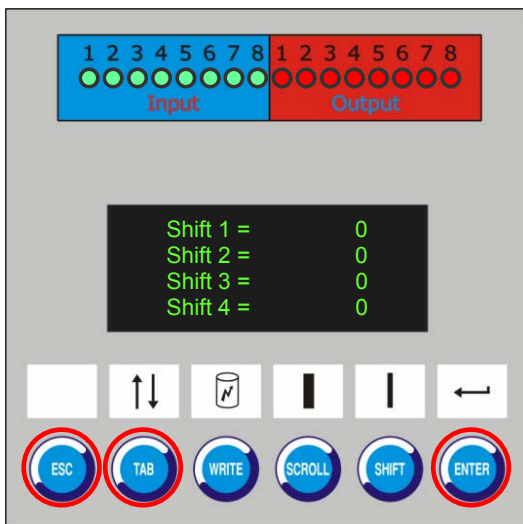

2.2.5.1 Shift Register 1

To access this page, select command <Shift 1=X> from the Shift Register menu.

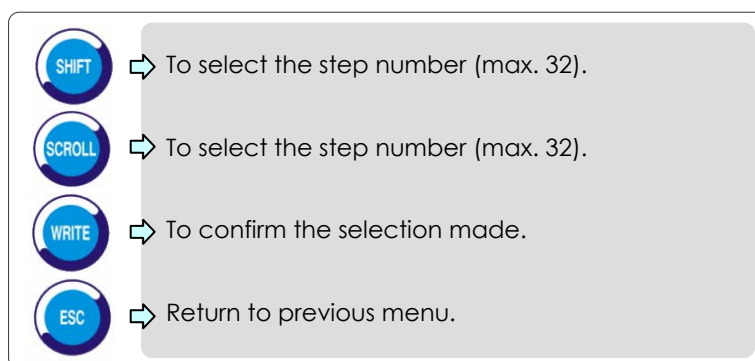
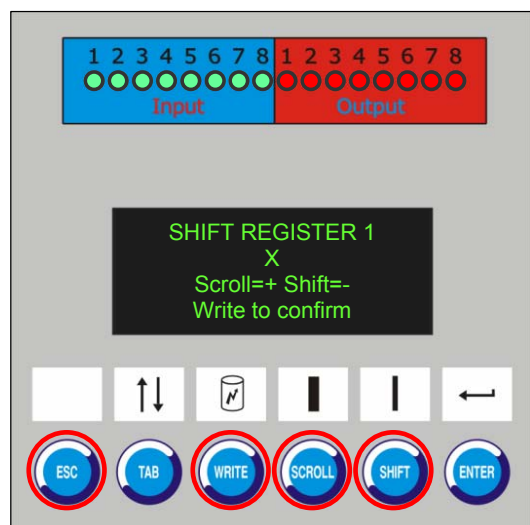

2.2.6 Consecutive

To access this page, select command <Consecutive> from the PROGRAMMING menu.

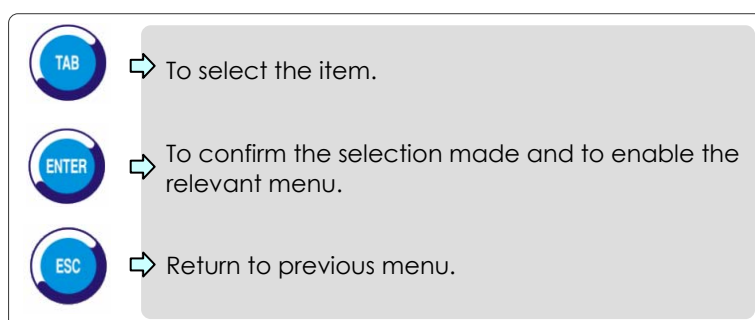
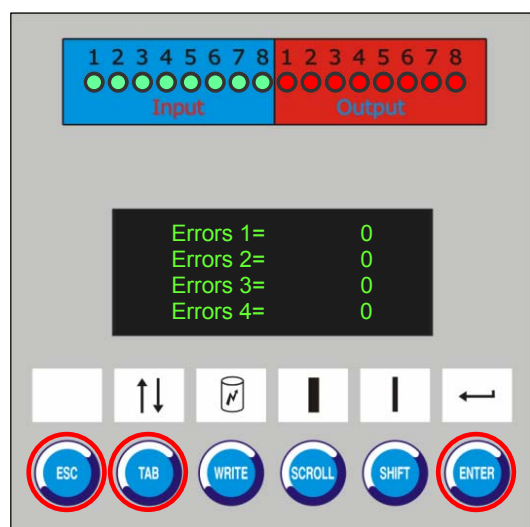

2.2.6.1 Errors 1= 0

To access this page, select command <Errors 1= 0> from the Consecutive menu.

This menu is used to set the number of consecutive errors (max. 10). After this number of consecutive errors the machine stops. If the set number is 0 (zero) the check is disabled.

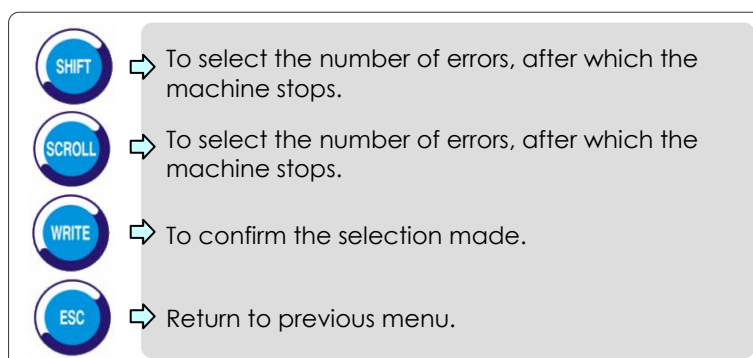
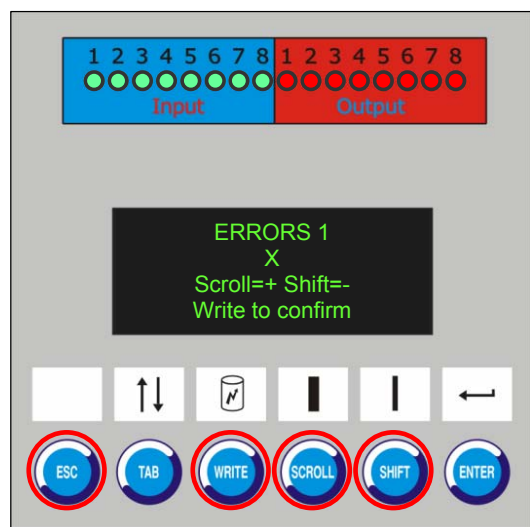

2.3. Production

To access this page, select command <Production> from the MAIN menu.

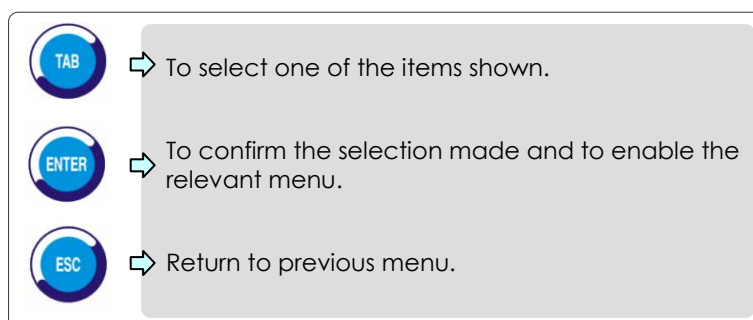
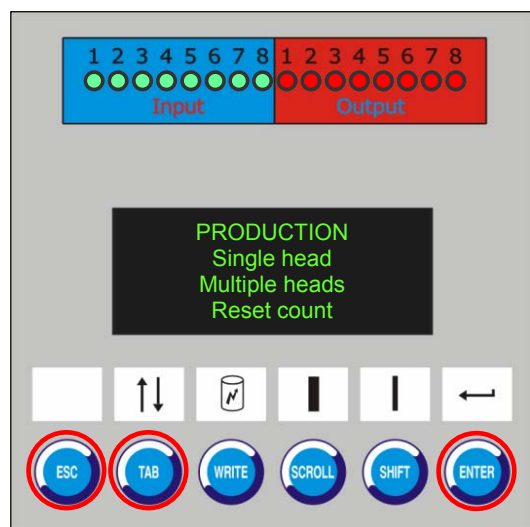

2.3.1 Single head

To access this page, select command <Single head> from the PRODUCTION menu.

This menu shows individually the last read code and the status of the counters for every reading head.

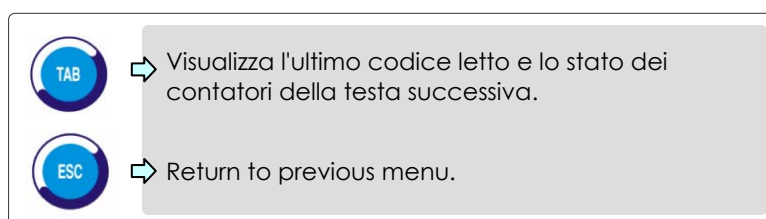
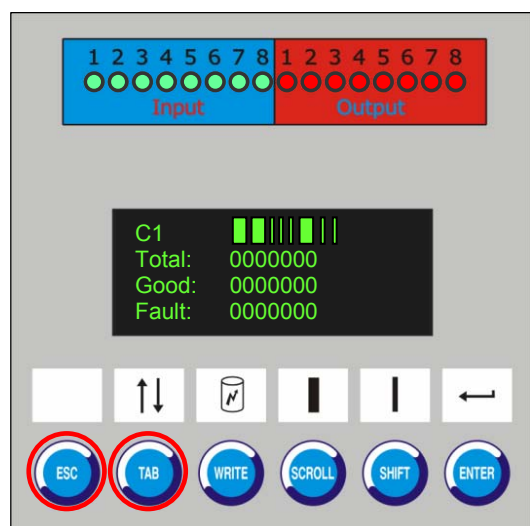

To exit this menu you shall enter the password.

2.3.2 Multiple heads

To access this page, select command <Multiple heads> from the PRODUCTION menu.

This menu shows at the same time the last code read by every reading head.

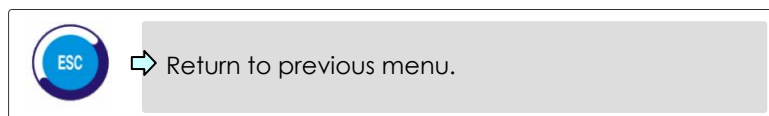
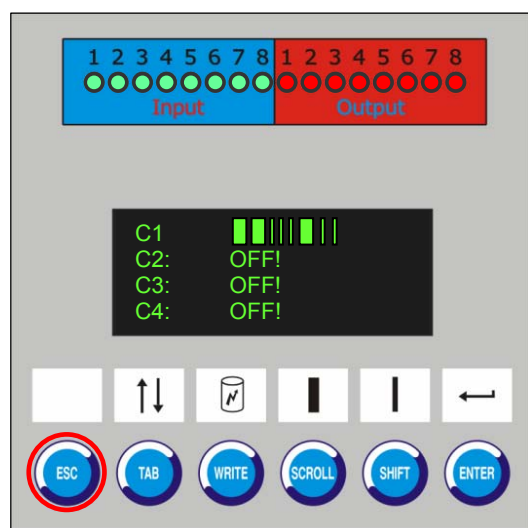

To exit this menu you shall enter the password.

2.3.3 Reset counters

To access this page, select command <Reset counters> from the PRODUCTION menu.

It enables you to reset the counters.

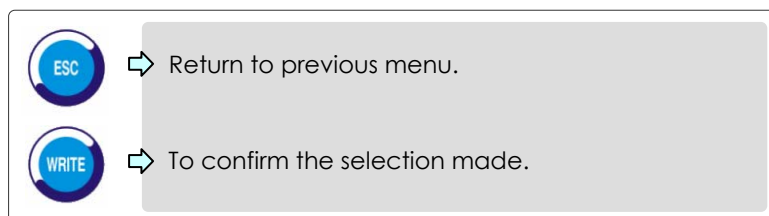
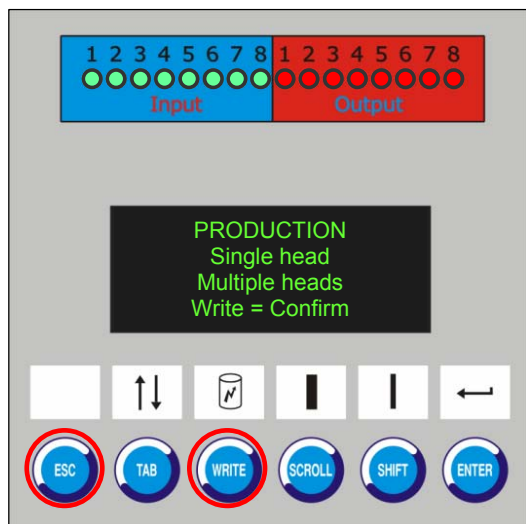

2.4. Language

To access this page, select command *<Language>* from the MAIN menu.

This menu allows the setting of the language to be used in the menu.

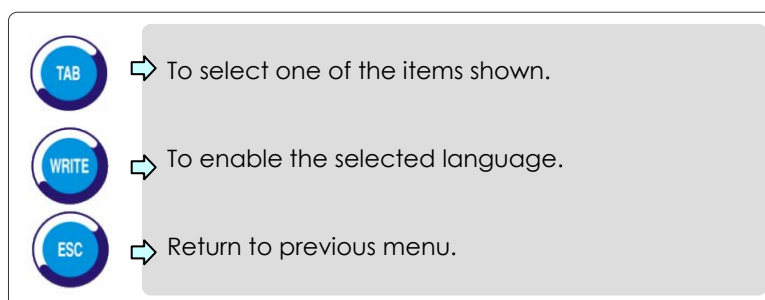
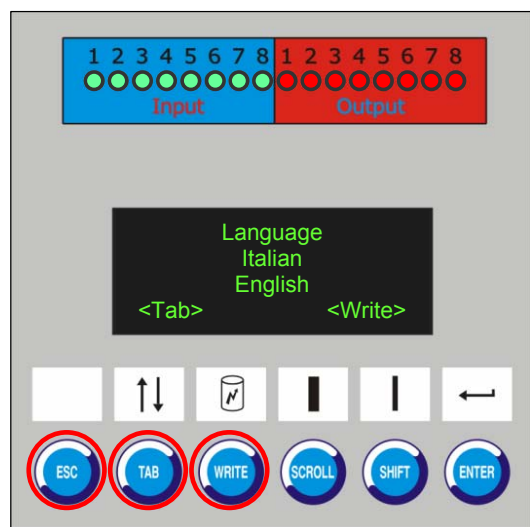

You can put an extra language in addition to the basic set languages.

2.5. Programming examples

2.5.1 Head no.1 setup

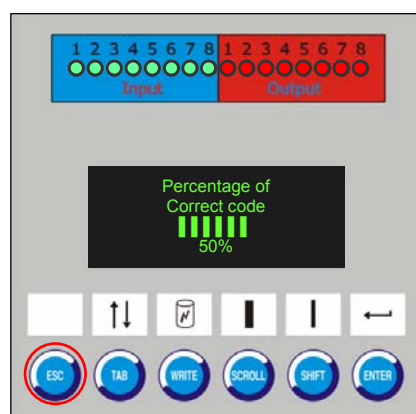
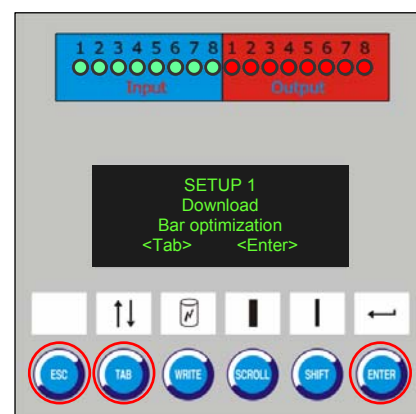
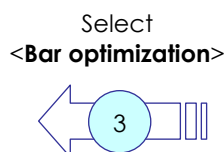
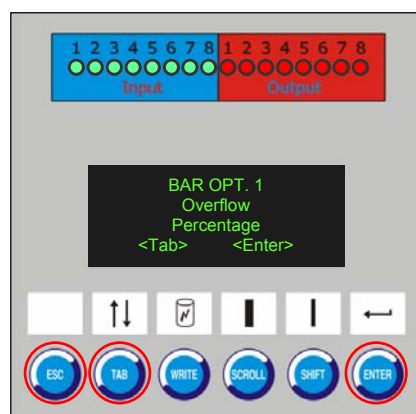
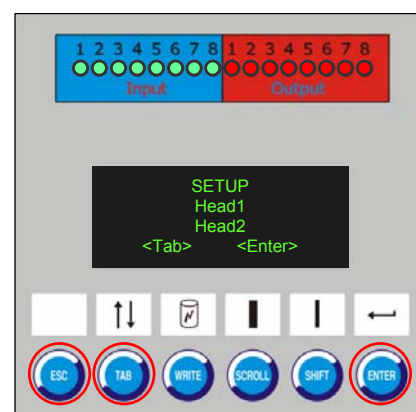
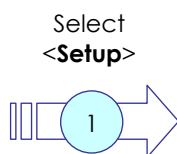
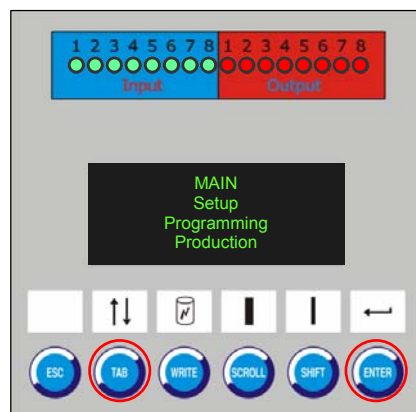

Locate the code to be read (e.g. a leaflet) at a distance of about 70mm from the laser reading head. Move the reading head up or down until you read the highest possible percentage of read codes. With some special codes (e.g. glossy) you may have to incline the reading head by about 15°.

A displayed percentage of > 50 is sufficient for correct reading of the code.

Press the <ESC> key to return to the main menu.

2.5.2 Enabling reading head no.1

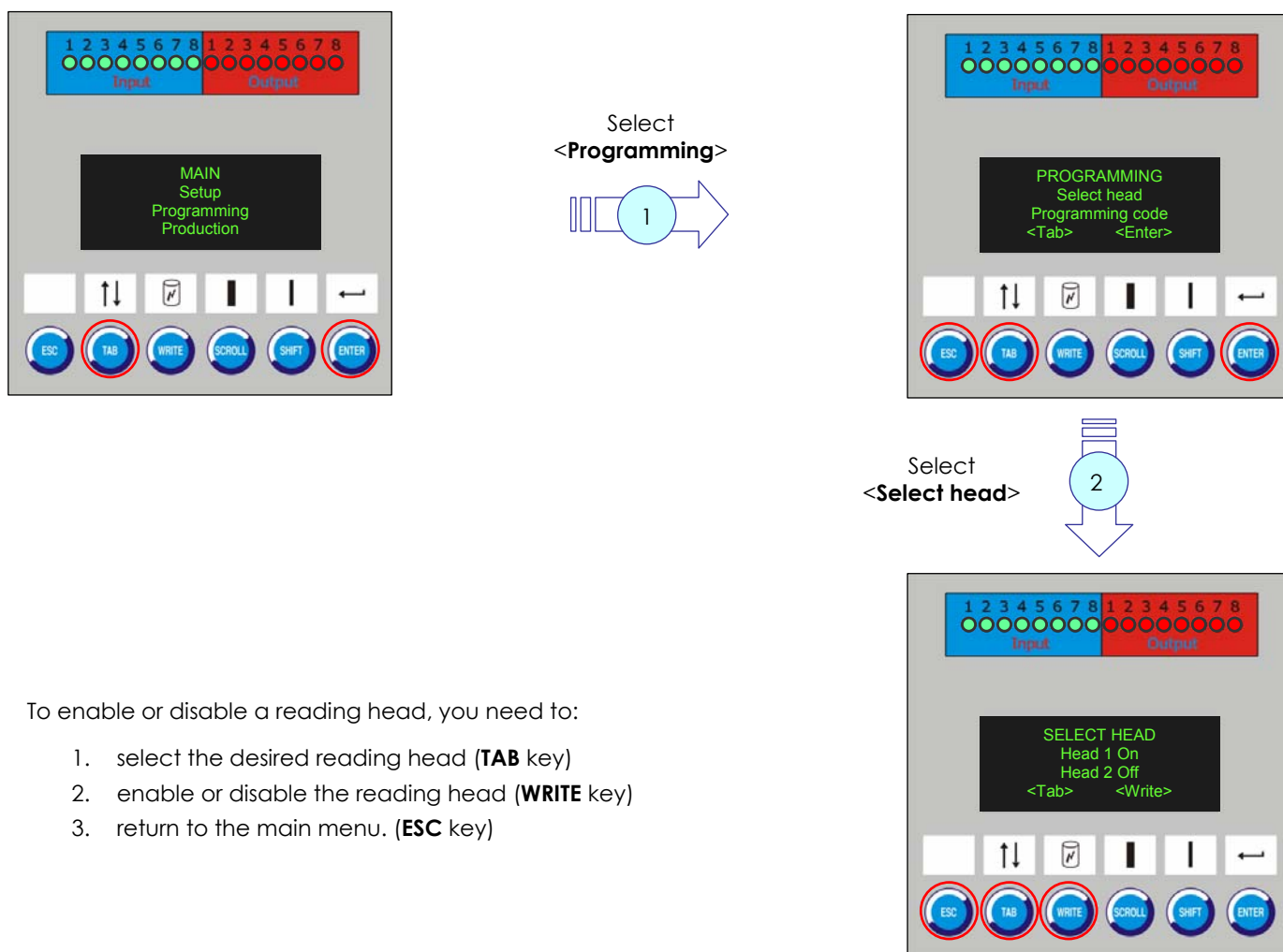

2.5.3 Code setting

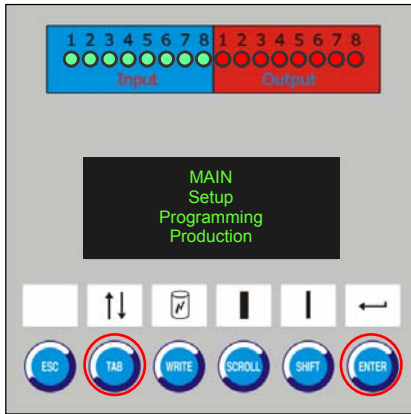

Select
<Programming>

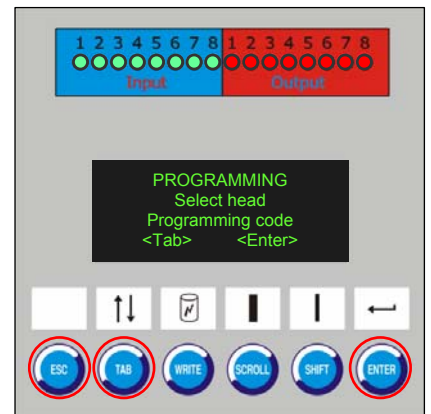
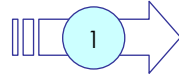

Select
<Programming code>

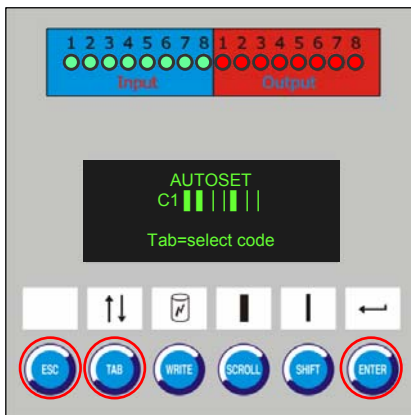
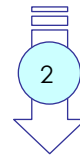

Select
<Autoset>

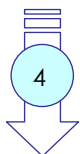
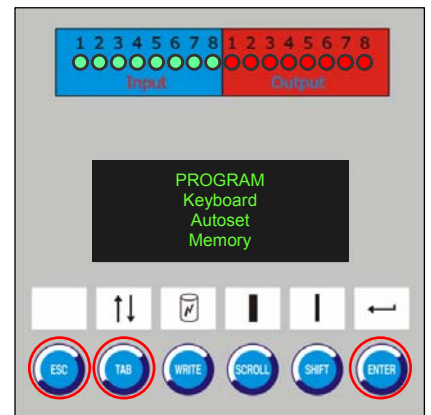
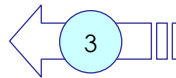

Press
<Enter>

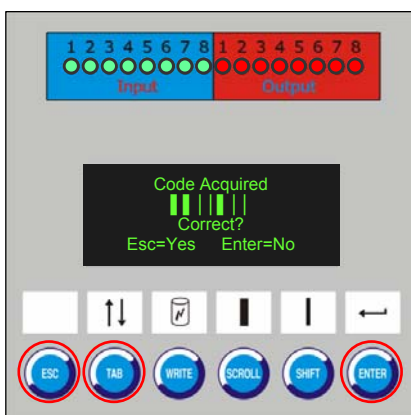

The displayed code is the code that the reading head sees; if reading is correct, press the <ESC> key. By pressing this key, you enter the "ACQUIRED" menu, where the operator is asked to confirm again; then press the <ESC> key.

2.5.4 Start of the production cycle

